



LISTA DE PRECIOS 2023

VÁLIDA A PARTIR DE ENERO 2023

COD LPB280323

HOMEA
PREMIUM

HOMEA

www.homea.mx

Email: ventas@homea.mx

Whatsapp: (442)258.0251

Tel: (442)216.3552

Lada sin Costo: 01(800)701.2121



REFRIGERADORES

BERTAZZONI	Código	Descripción	Color	Precio
	REF36DFIXNV	36" French door refrigerator - Freestanding - Stainless	Acero	\$4,310
	HK36MASFDX	Handles Kit Master Series 36" french door (901248)	Acero	\$448
	HK36PROFDX	Handles Kit Professional Series 36" french door (901249)	Acero	\$405
	HK36HERFDX	Handles Kit Heritage Series 36" french door (901250)	Acero	\$487
	DS2HERTSB	Black nickel decor set	Black nickel	\$1,119
	DS2HERTGO	Gold decor set	Gold	\$1,119
	DS2HERTPC	Copper decor set	Copper	\$1,119
<p>*Jaladeras no incluidas. Debe cotizarse equipo + jaladeras.</p>				
Especificaciones				
Size	36 in	Door storage	6 gallon sized bins	
Volume	Ref 15.9 cu.ft / Frz 6.6 cu.ft	Ice maker	Automatic ice maker 3.08 lbs / 24h	
Door finish	Stainless steel look	Settings	Super cool, Super freeze, Ice maker	
User interface	Internal digital LED touch interface	Lighting	Top and sidewall LED lights	
Refrigerator shelves	1 fixed and 4 height-adjustable, of which 1 retractable	Technical specifications		
Refrigerator crisper	1 large with preset temperature + 2 medium with adjustable humidity	Electrical supply	115 V 60 HZ - 190 W - 2.5 Amp	
Freezer compartment	2 drawers	Power connection	NEMA 5-15P with 67" power cord	
		Sound rating	45 dbA	
		Water connection	1/4" waterline with shut-off valve	
		Water supply pressure	MIN 0.15 MPa (1.5 Bar, 21.32 PSI) MAX 0.83 MPa (8.3 Bar, 120.96 PSI)	
		Certification	CEC,UL	
		Warranty	2 years parts & labor	
		Packaging dimensions	W 38 3/16" H 72 7/16" D 30 9/16"	
		Weight	298.0 lbs	



Productos con existencias disponibles. Lista de precios al público. Los precios están expresados en dolares americanos y no incluyen IVA.

BERTAZZONI	Código	Descripción	Color	Precio
	REF36BMBZPNV	36 inch Bottom Mount Built-in Refrigerator Panel Ready with ice maker & internal water dispenser. Reversible door.	Acero	\$7,895
	PROHK36PI	Handle kit - Professional series for REF36BMBZPNV (cod. tecnico 901462)		\$355
	MASHK36PI	Handle kit - Master series for REF36BMBZPNV (cod. tecnico 901463)		\$355
	HERHK36P	Handle kit - Heritage series for REF36BMBZPNV (cod. tecnico 901509)		\$711
	SP36BMX	Stainless steel door panels kit for REF36BMBZPNV (codigo tecnico 901609)		\$1,270
	CTXV	Union Kit for 2 units of REF36BMBZPNV (codigo tecnico 901602)		\$111
Especificaciones				
Size	36 in	Door storage	1 gallon sized + 2 height adjustable bins	
Volume	Ref 14.2 cu.ft / Frz 5.6 cu.ft	Ice maker	Automatic ice maker 3.9 lbs / 24hrs	
Door finish	Panel Ready	Settings	Super cool, Super freeze, Ice maker, Water filter replacement alarm. Water dispenser, Eco mode, vacation mode. Sabbath mode.	
User interface	Internal digital LED touch interface			
Lighting	Top and sidewall LED lights			
Refrigerator shelves	1 stationary + 2 height-adjustable			
Refrigerator drawers	1 + 1 fresco drawer with separate temperature control			
Freezer compartment	2 drawers			
Technical specifications				
		Electrical supply	115 V 60 HZ - 120 W - 3 Amp	
		Power connection	NEMA 5-15P with 90" power cord	
		Sound rating	43 dbA	
		Water connection	1/4" waterline with shut-off valve	
		Water supply pressure	25-80 psi (1.7-5.5 bar)	
		Certification	ADA Compliant,CB,CEC,ETL	
		Warranty	2 years parts & labor	
		Packaging dimensions	W 38 3/16" H 90 9/16" D 26 3/8"	
		Weight	417.0 lbs	



BERTAZZONI	Código	Descripción	Color	Precio	
	REF24PR	24" Bottom Mount integrated panel ready	White	\$2,232	
	Especificaciones				
	Worktop		Total volume	8.8 cut.ft.	
	Size	24 in	Refrigerator	6.4 cut.ft.	
	Type	Freestanding	Freezer	2.4 cut.ft.	
	Finishing	White	Technical specifications		
	Interface	Touch control on interior side wall	Voltage, Frequency, Amps	115V/60Hz - 0.8 Amps 85W	
	Illumination	LED on top	Power Connection	125V 3- prong plug 67"cord	
	Door storage	3 bins	Certification	UL / CEC / DOE	
	Icemaker	N/A	Energy star	Yes	
Refrigerator crisper	1 full-width with slider to store fruit avegetables	Warranty	2 years parts & labor		
Shelves	3 full-width	Packaging dimentions and weight	W 22.8" H 74" D 23"		
Added storage space	Full-width and depth storage space unde crisperr	Net Weight	157.63 lbs		
Drawer freezer	3	Gross Weight	144.4 lbs		

SIDE

FRONT

TOP

* HASTA AGOTAR EXISTENCIAS

ESTUFAS 36" MASTER SERIES

BERTAZZONI	Código	Descripción	Color	Precio
	MAST365GASXELP	36" Master Series range - Gas oven - 5 aluminum burners LP	Acero	\$5,116
	MAST365GASNEE	36" Master Series range - Gas oven - 5 aluminum burners	Negro	\$5,770
	MAST365GASBIE	36" Master Series range - Gas oven - 5 aluminum	Blanco	\$5,770
	MAST3656ASXE	36" Master Series range - Gas oven - 5 aluminum	Acero	\$5,116
	Especificaciones			
	Worktop		Oven Cavity	
	Size	36 in	Oven configuration	single
	Cooking zones	5	Oven fuel	gas
	Gas zones	5 Burners	Oven type	fan assisted gas
	Worktop type	gas	Oven broiler type	gas
	Knobs	solid metal	Oven functions	bake / broiler / convection bake
	Burner type	aluminium	Oven volume	5.9 ft ³
	Grates	cast iron	Oven convection system	dual horizontal fans
	Continuous grating	yes	Inner oven door	triple
	Thermocouple safety device	yes	Removable inner glass	yes
	One-hand ignition	yes	Cooling fan	yes
	Backguard	yes	Oven levels	7
	Simmer ring	yes	Door hinge	soft-motion
	Cookinf zones		Wire-shelves	4
	Dual wok	1300 BTU/h - 19 000 BTU/h (1)	Tray	1 enamelled
	Rapid	2500 BTU/h - 10 400 BTU/h (1)	Grill trivet for tray	yes
Semi-rapid	1500 BTU/h - 5900 BTU/h (2)	Oven lights	double lateral	
Auxiliary	750 BTU/h - 3500 BTU/h (1)	Bottom		
		Legs	stainless steel	
		Technical specifications		
		Electrical requirements	120V 60 Hz - 300W 2.5 A	



ESTUFAS 36" PROFESSIONAL SERIES

BERTAZZONI	Código	Descripción	Color	Precio
	PROF366GASXT	36" Professional Series range - Gas oven - 6 brass burners	Acero	\$5,883
	PROF366GASNET	36" Professional Series range - Gas oven - 6 brass burners	Negro	\$7,884
	PROF366GASBIT	36" Professional Series range - Gas oven - 6 brass burners	Blanco	\$7,884
	PROF366GASGIT	36" Professional Series range - Gas oven - 6 brass burners	Amarillo	\$7,884
	PROF366GASROT	36" Professional Series range - Gas oven - 6 brass burners	Rojo	\$7,884
	PROF366GASXTLP	36" Professional Series range - Gas oven - 6 brass burners - LP version	Versión LP	\$5,883
	PROF366GASART	36" Professional Series range - Gas oven - 6 brass burners	Naranja	\$7,884

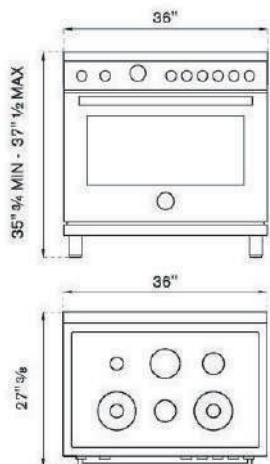



Especificaciones

Worktop		Oven Cavity	
Size	36 in	Oven broiler type	gas
Cooking zones	6	Oven functions	bake / broiler / convection bake
Gas zones	6 Burners	Oven volume	4.8 ft ³
Worktop type	gas	Oven convection system	dual horizontal fans
Knobs	metal coated	Inner oven door	triple
Burner type	brass	Removable inner glass	yes
Grates	cast iron	Cooling fan	yes
Continuous grating	yes	Oven levels	7
Thermocouple safety device	yes	Door hinge	soft-close
One-hand ignition	yes	Sliding shelves	1 set of telescopic glides
Backguard	yes	Wire-shelves	2
Work adapter	yes	Tray	1 enamelled
Simmer ring	yes	Grill trivet for tray	yes
Cookinf zones		Oven lights	double lateral
Dual wok	1300 BTU/h - 19 000 BTU/h (2)	Bottom	
Rapid	2500 BTU/h - 10 400 BTU/h (1)	Legs	stainless steel
Semi-rapid	1500 BTU/h - 5900 BTU/h (2)	Technical specifications	
Auxiliary	750 BTU/h - 3500 BTU/h (1)	Electrical requirements	120V 60 Hz - 300W 2.5 A

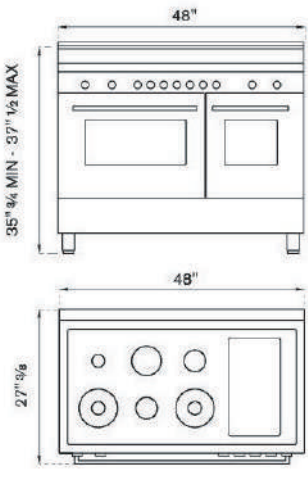

ESTUFAS 48" MASTER SERIES

BERTAZZONI	Código	Descripción	Color	Precio
	MAST486GGASXELP	48" Master Series range - Gas Oven - 6 aluminum - LP	Acero	\$9,693
	MAST486GGASNEE	48" Master Series range - Gas Oven - 6 aluminum burners + griddle	Negro	\$10,475
	MAST486GGASBIE	48" Master Series range - Gas Oven - 6 aluminum	Blanco	\$10,475
	MAST486GGASXE	48" Master Series range - Gas Oven - 6 aluminum	Acero	\$9,693
				
				
				
Especificaciones				
Worktop		Oven Cavity		
Size	48 in	Oven configuration	double	
Cooking zones	7	Oven fuel	gas	
Gas zones	6 Burners	Oven convection system	dual horizontal fans	
Griddle zones	electric	Main oven type	fan assisted gas	
Worktop type	electric / gas	Main oven broiler type	gas	
Knobs	solid metal	Main oven functions	bake / broiler / convection bake	
Burner type	aluminium	Main oven volume	4.8 ft ³	
Grates	cast iron	Auxiliary oven type	gas conventional	
Continuous grating	yes	Auxiliary oven functions	bake	
Thermocouple safety device	yes	Auxiliary oven volume	2.4 ft ³	
One-hand ignition	yes	Inner oven door	triple	
Backguard	yes	Removable inner glass	yes	
Simmer ring	yes	Cooling fan	yes	
Cooking zones		Oven levels	7	
Dual wok	1300 BTU/h - 19 000 BTU/h (2)	Door hinge	soft-motion	
Rapid	2500 BTU/h - 10 400 BTU/h (1)	Wire-shelves	4	
Semi-rapid	1500 BTU/h - 5900 BTU/h (2)	Tray	1 enamelled	
Auxiliary	750 BTU/h - 3500 BTU/h (1)	Grill trivet for tray	yes	
Griddle power	1100 W	Oven lights	double lateral	
Griddle drip tray	yes	Bottom		
Griddle dual control	yes	Legs	stainless steel	
		Technical specifications		
		Electrical requirements	120V 60 Hz - 1200W 10 A	



ESTUFAS 48" PROFESSIONAL SERIES

BERTAZZONI	Código	Descripción	Color	Precio
	PROF486GGASXT	48" Professional Series range - Gas Oven - 6 brass burners + griddle	Acero	\$10,329
	PROF486GGASNET	48" Professional Series range - Gas Oven - 6 brass burners + griddle	Negro	\$11,882
	PROF486GGASBIT	48" Professional Series range - Gas Oven - 6 brass burners + griddle	Blanco	\$11,882
	PROF486GGASGIT	48" Professional Series range - Gas Oven - 6 brass burners + griddle	Amarillo	\$11,882
	PROF486GGASART	48" Professional Series range - Gas Oven - 6 brass burners + griddle	Naranja	\$11,882
	PROF486GGASROT	48" Professional Series range - Gas Oven - 6 brass burners + griddle	Rojo	\$11,882
	PROF486GGASXTLP	48" Professional Series range - Gas Oven - 6 brass burners + griddle - LP version	Versión LP	\$10,329
	Especificaciones			
Worktop		Oven Cavity		
Size	48 in	Oven configuration	double	
Cooking zones	7	Oven fuel	gas	
Gas zones	6 Burners	Main oven type	fan assisted gas	
Griddle zones	electric	Main oven broiler type	gas	
Worktop type	electric / gas	Main oven functions	bake / broiler / convection bake	
Knobs	metal coated	Main oven volume	4.8 ft ³	
Burner type	brass	Auxiliary oven type	gas conventional	
Grates	cast iron	Auxiliary oven broiler type	gas	
Continuous grating	yes	Auxiliary oven functions	bake	
Thermocouple safety device	yes	Auxiliary oven volume	2.4 ft ³	
One-hand ignition	yes	Inner oven door	triple	
Backguard	yes	Removable inner glass	yes	
Work adapter	yes	Cooling fan	yes	
Simmer ring	yes	Oven levels	7	
Cooking zones		Door hinge	soft-close	
Dual wok	1300 BTU/h - 19 000 BTU/h (2)	Sliding shelves	2 sets of telescopic glides	
Rapid	2500 BTU/h - 10 400 BTU/h (1)	Wire-shelves	5	
Semi-rapid	1500 BTU/h - 5900 BTU/h (2)	Tray	1 enamelled	
Auxiliary	750 BTU/h - 3500 BTU/h (1)	Grill trivet for tray	yes	
Griddle power	1100 W	Oven lights	double lateral	
Griddle drip tray	yes	Bottom		
Griddle dual control	yes	Legs	stainless steel	
Technical specifications				
		Electrical requirements	120V 60 Hz - 1200W 10 A	

ESTUFAS SERIE HERITAGE 36"

BERTAZZONI	Código	Descripción	Color	Precio
	HERT366GASNET	Estufa profesional estilo Heritage Negro mate de 36"	Negro	\$7,888
	HERT366GASAVT	Estufa profesional estilo Heritage Crema mate de 36"	Crema	\$7,888
	HERT366GASXT	Estufa profesional estilo Heritage Acero de 36"	Acero	\$7,888
Especificaciones				
Worktop		Oven Cavity		
Size	36 in	Oven configuration	single	
Cooking zones	6	Oven fuel	gas	
Gas zones	6 Burners	Oven type	fan assisted gas	
Worktop type	gas	Oven broiler type	gas	
Knobs	solid metal	Oven functions	bottom bake / broiler / de-frosting / dehydrate / gas convection / oven light	
Burner type	brass	Oven volume	4.4 ft ³	
Grates	cast iron	Oven convection system	single	
Continuous grating	yes	Inner oven door	triple	
Thermocouple safety device	yes	Removable inner glass	yes	
One-hand ignition	yes	Oven controls	knobs	
Backguard	yes	Cooling fan	yes	
Work adapter	yes	Oven levels	5	
Simmer ring	yes	Door hinge	soft-motion	
Cooking zones		Sliding shelves	1 set of telescopic glides	
Dual wok	750 BTU/h - 18 000.00 BTU/h	Wire-shelves	2	
Rapid	2500 BTU/h - 11 000.00 BTU/h (1)	Tray	1 enamelled	
Semi-rapid	1500 BTU/h - 6500 BTU/h (3)	Grill trivet for tray	yes	
Auxiliary	750 BTU/h - 3400 BTU/h (1)	Oven lights	double	
Technical specifications		Bottom		
Electrical requirements	120 Vac - 60 Hz - 1.50 A	Storage compartment	flap	
		Legs	stainless steel	

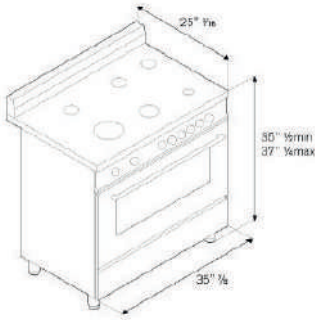

CAMPANAS SERIE HERITAGE 36"

BERTAZZONI	Código	Descripción	Color	Precio
	KC36HERTAV	Campana pared profesional estilo Heritage 36"	Crema mate	\$1,086
	KC36HERTX	Campana pared profesional estilo Heritage 36"	Acero	\$1,086
	KC36HERTNE	Campana pared profesional estilo Heritage 36"	Negro	\$1,086
Especificaciones				
Worktop		Hood control	electronic with buttons	
Size	36 in	Filters type	baffle stainless steel	
Hood		Lights	2 halogen	
Hood type	wall mount	Max extraction power	600 CFM	
Motor	1	Sound Level	59 dB(A)	
Speed	3	Technical specifications		
Hood finishing	stainless steel and matt color	Electrical requirements	120 V - 60 Hz - 3.30 A	
Duct cover	included	Power rating	400 W	
Motor para campana HERITAGE 36"				
K36HERTX	Motor 600 CFMS			\$2,004
*Se debe cotizar Campana más Motor.				

ACCESORIOS OPCIONALES

Código	Descripción	Precio
DSHERTKHGO	Decor Set 1- Range & Hood Kit : Gold Finish	\$1,919
DSHERTKHPC	Decor Set 1- Range & Hood Kit : Polished Copper Finish	\$1,919
DSHERTKHSB	Decor Set 1- Range & Hood Kit : Matt Satin Black Finish	\$1,919

ESTUFAS SERIE HERITAGE 48"

BERTAZZONI	Código	Descripción	Color	Precio
	HERT486GGASNET	Estufa profesional estilo Heritage Negro mate de 48"	Negro	\$12,923
	HERT486GGASAVT	Estufa profesional estilo Heritage Crema mate de 48"	Crema	\$12,923
	HERT486GGASXT	Estufa profesional estilo Heritage Acero mate de 48"	Acero	\$12,923
Especificaciones				
Worktop		Oven Cavity		
Size	48 in	Oven configuration	double	
Cooking zones	7	Oven fuel	gas	
Gas zones	6 Burners	Oven type	fan assisted gas	
Griddle zones	electric	Oven broiler type	gas	
Worktop type	electric / gas	Oven functions	bottom bake / broiler / de-frosting / dehydrate / gas convection / oven light	
Worktop design	stainless steel squared	Oven volume	3.6 ft ³	
Worktop controls	knobs	Auxiliary oven type	gas conventional	
Knobs	solid metal	Auxiliary oven broiler type	gas	
Burner type	brass	Auxiliary oven functions	bottom bake / oven light	
Grates	cast iron	Auxiliary oven volume	2.2 ft ³	
Continous grating	yes	Oven controls	knobs	
Thermocouple safety device	yes	Inner oven door	triple	
One-hand ignition	yes	Removable inner glass	yes	
Backguard	yes	Cooling fan	yes	
Work adapter	yes	Oven levels	5	
Simmer ring	yes	Door hinge	soft-motion	
Cookinf zones		Sliding shelves	2 sets of telescopic glides	
Dual wok	750 BTU/h - 18 000.00 BTU/h	Wire-shelves	2	
Rapid	2500 BTU/h - 11 000.00 BTU/h (1)	Tray	1 enamelled	
Semi-rapid	1500 BTU/h - 6500 BTU/h (3)	Grill trivet for tray	yes	
Auxiliary	750 BTU/h - 3400 BTU/h (1)	Oven lights	double diagonal	
Technical specifications		Bottom		
Electrical requirements	120 Vac - 60 Hz - 1.50 A	Storage compartment	flap	
		Legs	stainless steel	

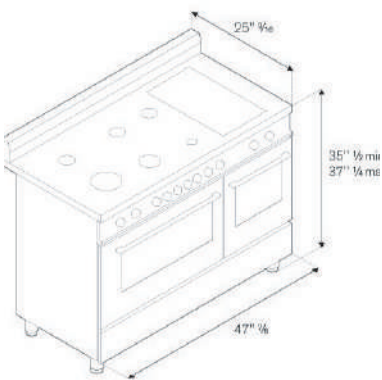

CAMPANAS SERIE HERITAGE 48"

BERTAZZONI	Código	Descripción	Color	Precio
	KC48HERTNE	Campana pared profesional estilo Heritage 48"	Negro mate	\$1,349
	KC48HERTAV	Campana pared profesional estilo Heritage 48"	Crema mate	\$1,349
	KC48HERTX	Campana pared profesional estilo Heritage 48"	Acero	\$1,349
Especificaciones				
Worktop				
Size	48 in	Hood control	electronic with buttons	
Hood		Filters type	baffle stainless steel	
Hood type	wall mount	Lights	2 halogen	
Motor	1	Max extraction power	600 CFM	
Speed	3	Sound Level	59 dB(A)	
Hood finishing	stainless steel and matt color	Technical specifications		
Duct cover	included	Electrical requirements	120 V - 60 Hz - 3.30 A	
		Power rating	400 W	
Motor para campana HERITAGE 36"				
K48HERTX	Motor 600 CFMS			\$2,178
*Se debe de cotizar campana + motor.				



PARRILLAS ENCIMERAS DE GAS BERTAZZONI

BERTAZZONI	Código	Descripción	Color	Precio
	P905Cprox	90cm Gas on steel Cooktop, 5 Brass Burners	Acero	\$1,184
	Especificaciones			
	Worktop		Cooking zones	
	Size	90 cm	Front right	1 auxiliary 0.48 kW - 1.00 kW
	Worktop surface	stainless steel	Back right	1 rapid 1.05 kW - 3.00 kW
	Layout	5 burners	Center	1 wok dual 0.48 kW - 5.00 kW
	Worktop controls	knobs	Front left	1 semi-rapid 0.60 kW - 1.75 kW
	Knobs	metal	Back left	1 semi-rapid 0.60 kW - 1.75 kW
	Pan supports	cast iron	Technical specifications	
	Burner type	brass	Electrical requirements	220/240, 50/60 Hz, 1A, 1W
Work burner	5 kW dual			
Flame failure device	-			
One-hand ignition	-			
Standard accessories	-			

PARRILLAS DE GAS

BERTAZZONI	Código	Descripción	Color	Precio
 	PROF486GRTBXT	48" Rangetop 6 Brass Burners + Griddle Professional Series	Acero	\$4,006
	Especificaciones			
	Worktop		Cooking zones	7
	Size	48 in	Griddle zones	electric
	Maintop	6 burners + stainless steel griddle with cover	Worktop type	electric/gas
	Burner power	2 power burners 19000 BTU 1 rapid burner 10400 BTU 2 medium burners 5900 BTU 1 simmer burner 3500 BTU	Worktop desing	stainless steel squared
			Knobs	solid metal
			Burner type	brass
	Ignition system	Electric with thermocouple safety device	Technical specifications	
	Grates	Cast iron	Electrical requirements	120 V - 60 Hz - 10 A
		Power rating	1100 W	

BERTAZZONI	Código	Descripción	Color	Precio
 	MAST486GRTBXT	48" Rangetop 6 Brass Burners + Griddle Master Series	Acero	\$4,006
	Especificaciones			
	Worktop		Cooking zones	7
	Size	48 in	Griddle zones	electric
	Maintop	6 burners + stainless steel griddle with cover	Worktop type	electric/gas
	Burner power	2 power burners 19000 BTU 1 rapid burner 10400 BTU 2 medium burners 5900 BTU 1 simmer burner 3500 BTU	Worktop desing	stainless steel squared
			Knobs	solid metal
			Burner type	brass
	Ignition system	Electric with thermocouple safety device	Technical specifications	
	Grates	Cast iron	Electrical requirements	120 V - 60 Hz - 10 A
		Power rating	1100 W	

BERTAZZONI	Código	Descripción	Color	Precio
	PROF366RTBXT	36" Rangetop 6 Brass Burners Profesional Series	Acero	\$2,616
	Especificaciones			
Worktop		Cooking zones	6	
Size	36 in	Griddle zones	electric	
Maintop	6 burner	Worktop type	electric/gas	
Burner power	2 power burners 19000 BTU 1 rapid burner 10400 BTU 2 medium burners 5900 BTU 1 simmer burner 3500 BTU	Worktop desing	stainless steel	
		Knobs	solid metal	
		Burner type	brass	
Technical specifications				
Ignition system	Electric with thermocouple safety device	Electrical requirements	120 V - 60 Hz - 1 A	
Grates	Cast iron	Power rating	1 W	

BERTAZZONI	Código	Descripción	Color	Precio
	MAST366RTBXT	36" Rangetop 6 Brass Burners Master Series	Acero	\$2,616
	Especificaciones			
Worktop		Cooking zones	6	
Size	36 in	Griddle zones	electric	
Maintop	6 burner	Worktop type	electric/gas	
Burner power	2 power burners 19000 BTU 1 rapid burner 10400 BTU 2 medium burners 5900 BTU 1 simmer burner 3500 BTU	Worktop desing	stainless steel	
		Knobs	solid metal	
		Burner type	brass	
Technical specifications				
Ignition system	Electric with thermocouple safety device	Electrical requirements	120 V - 60 Hz - 1 A	
Grates	Cast iron	Power rating	0.01 W	



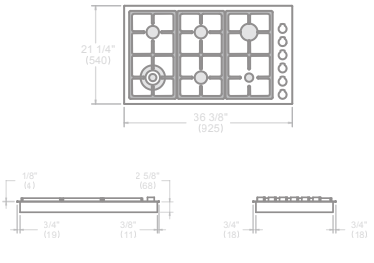

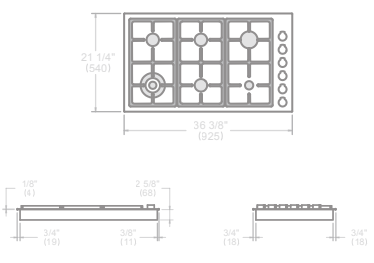
BERTAZZONI	Código	Descripción	Color	Precio
 	MAST366QBXT	36" Built-in cooktop master series	Acero	\$1,863
	Especificaciones			
Worktop			Cooking zones	6
Size	36 in		Griddle zones	electric
Maintop	6 burner		Worktop type	electric/gas
Burner power	1 power burners 17000 BTU 1 rapid burner 10400 BTU 3 medium burners 6000 BTU 1 simmer burner 3750 BTU		Worktop desing	stainless steel
			Knobs	solid metal
			Burner type	brass
Technical specifications				
Ignition system	Electric with thermocouple safety device		Electrical requirements	120 V - 60 Hz - 1 A
Grates	Cast iron		Power rating	1 W

BERTAZZONI	Código	Descripción	Color	Precio
 	PROF366QBXT	36" Built-in cooktop professional series	Acero	\$1,863
	Especificaciones			
Worktop			Cooking zones	6
Size	36 in		Griddle zones	electric
Maintop	6 burner		Worktop type	electric/gas
Burner power	1 power burners 17000 BTU 1 rapid burner 10400 BTU 3 medium burners 6000 BTU 1 simmer burner 3750 BTU		Worktop desing	stainless steel
			Knobs	solid metal
			Burner type	brass
Technical specifications				
Ignition system	Electric with thermocouple safety device		Electrical requirements	120 V - 60 Hz - 1 A
Grates	Cast iron		Power rating	0.01 W



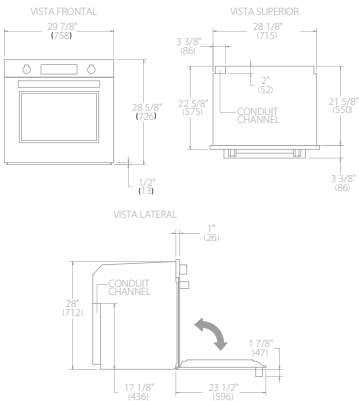

HORNOS CONVECCIÓN 30"

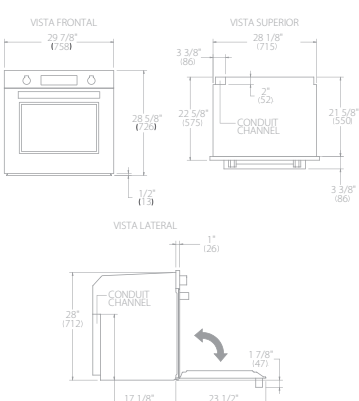
BERTAZZONI	Código	Descripción	Color	Precio
 	PROF30FSEXT	30" Single Convection Oven Top Version Profesional Series	Acero	\$5,421
	Especificaciones			
Worktop		Cavity finishing	pyrolytic grey enamel	
Size	30 in	Oven handle	metal	
Oven configuration	single	Cooling fan	yes	
Oven fuel	electric	Oven levels	7	
Oven type	self-clean	Timer	touch digital programmer	
Oven broiler type	electric	Auto cooking modes	33 preset / with assistant	
Oven functions	bake / broiler / convection / convection bake / convection broiler / defrosting / dehydrate / proofing / pyrolytic self clean / turbo / warming	Door hinge	soft-motion	
Overall volume	4.10 ft ³	Sliding shelves	1 full extension	
		Wire-shelves	2 heavy gauge chromed	
Oven convection system	dual diagonal with heating element	Tray	1 enamelled	
		Grill trivet for tray	yes	
Oven controls	knobs / touch LCD hi res display	Oven lights	double	
Inner oven door	quadruple	Technical specifications		
Removable inner glass	yes	Electrical requirements	120/240 Vac - 60 Hz - 30 A	
		Power rating	5400 W	

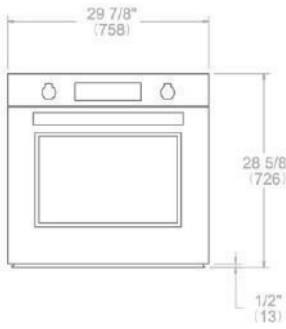
BERTAZZONI	Código	Descripción	Color	Precio
 	MAST30FSEXT	30" Single Convection Oven Top Version Master Series	Acero	\$5,421
	Especificaciones			
Worktop		Oven handle	metal	
Size	30 in	Cooling fan	yes	
Oven configuration	single	Oven levels	7	
Oven fuel	electric	Timer	touch digital programmer	
Oven type	self-clean	Door hinge	soft-close	
Oven broiler type	electric	Wire-shelves	2 heavy gauge chromed	
Oven functions	bake / broiler / convection / convection bake / convection broiler / defrosting / dehydrate / proofing / pyrolytic self clean / turbo / warming	Tray	1 enamelled	
Overall volume	4.10 ft ³	Grill trivet for tray	yes	
		Oven lights	single	
Oven convection system	dual diagonal with heating element	Technical specifications		
Oven controls	knobs / touch LED display	Electrical requirements	120/240 V - 60 Hz - 30 A	
Inner oven door	quadruple	Power rating	5400 W	
Removable inner glass	yes			
Cavity finishing	pyrolytic grey enamel			

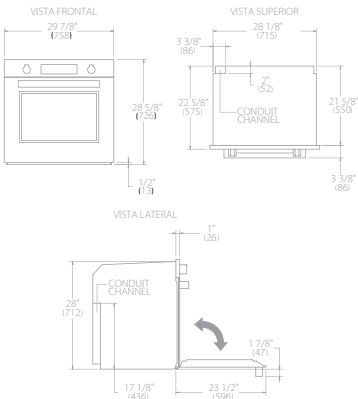
BERTAZZONI	Código	Descripción	Color	Precio
 	PROF30FSEXV	30" Single Convection Oven Value Version Profesional Series	Acero	\$4,035
	Especificaciones			
Worktop		Oven handle	metal	
Size	30 in	Cooling fan	yes	
Oven configuration	single	Oven levels	7	
Oven fuel	electric	Timer	touch digital programmer	
Oven type	self-clean	Door hinge	soft-motion	
Oven broiler type	electric	Wire-shelves	1 flat / 1 shaped	
Oven functions	bake / broil / convection / convection bake / convection broil / defrosting / dehydrate / proofing / pyrolytic self clean / pizza / sabbath mode / warming	Tray	1 baking tray whit roasting trivet	
Overall volume	4.10 ft ³	Grill trivet for tray	yes	
Oven convection system	dual diagonal with heating element	Oven lights	single	
Oven controls	knobs / touch LED display	Technical specifications		
Inner oven door	quadruple	Electrical requirements	120/240 V - 60 Hz - 30 A	
Removable inner glass	yes	Power rating	5400 W	
Cavity finishing	pyrolytic grey enamel			

BERTAZZONI	Código	Descripción	Color	Precio
 	MAST30FSEXV	30" Single Convection Oven Value Version Master Series	Acero	\$4,035
	Especificaciones			
Worktop		Oven handle	metal	
Size	30 in	Cooling fan	yes	
Oven configuration	single	Oven levels	7	
Oven fuel	electric	Timer	touch digital programmer	
Oven type	self-clean	Door hinge	soft-motion	
Oven broiler type	electric	Wire-shelves	2 heavy gauge chromed	
Oven functions	bake / broil / convection / convection bake / convection broil / pizza / defrost / dehydrate / fast preheat / keep warm / light / proof / self clean / timer	Tray	1 enamelled	
Overall volume	4.10 ft ³	Grill trivet for tray	yes	
Oven convection system	dual diagonal with heating element	Oven lights	single	
Oven controls	knobs / touch LED display	Technical specifications		
Inner oven door	quadruple	Electrical requirements	120/240 V - 60 Hz - 30 A	
Removable inner glass	yes	Power rating	5400 W	
Cavity finishing	pyrolytic grey enamel			

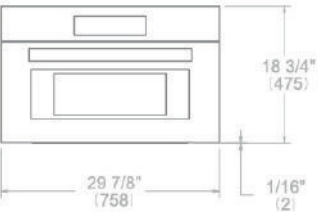
BERTAZZONI	Código	Descripción	Color	Precio
 	PROF30SOEX	30" Convection Speed Oven Profesional Series	Acero	\$3,083
	Especificaciones			
Worktop		Oven handle	metal	
Size	30 in	Microwave power	200 / 400 / 600 / 800 / 1000	
Oven configuration	single	Oven levels	2	
Oven fuel	electric	Timer	yes	
Oven type	self-clean	Door hinge	soft-motion	
Oven broiler type	electric	Wire-shelves	1 flat / 1 shaped	
Oven functions	broil / convection / microwave / convection broil / microwave whit broiler/ pizza / defrost by time / defrost by weight / light / popcorn / recipes / timer	Tray	1 glass	
Overall volume	1.34 ft ³	Grill trivet for tray	yes	
Oven convection system	single whit ring heating element	Oven lights	single	
Oven controls	touch LED display	Technical specifications		
Inner oven door	double	Electrical requirements	120/240 V - 60 Hz - 16 A	
Removable inner glass	yes	Power rating	1500 W	
Cavity finishing	stainless steel			

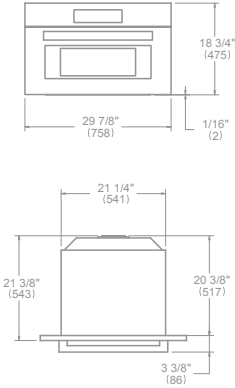
BERTAZZONI	Código	Descripción	Color	Precio
 	MAST30SOEX	30" Convection Speed Oven Master Series	Acero	\$3,083
	Especificaciones			
Worktop		Oven handle	metal	
Size	30 in	Microwave power	200 / 400 / 600 / 800 / 1000	
Oven configuration	single	Oven levels	2	
Oven fuel	electric	Timer	yes	
Oven type	self-clean	Door hinge	soft-motion	
Oven broiler type	electric	Wire-shelves	1 flat / 1 shaped	
Oven functions	broil / convection / microwave / convection broil / microwave whit broiler/ pizza / defrost by time / defrost by weight / light / popcorn / recipes / timer	Tray	1 glass	
Overall volume	1.34 ft ³	Grill trivet for tray	yes	
Oven convection system	single whit ring heating element	Oven lights	single	
Oven controls	touch LED display	Technical specifications		
Inner oven door	double	Electrical requirements	120/240 V - 60 Hz - 30 A	
Removable inner glass	yes	Power rating	1500 W	
Cavity finishing	stainless steel			

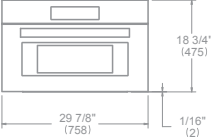
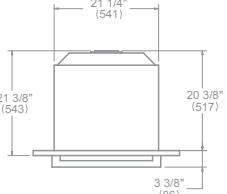
BERTAZZONI	Código	Descripción	Color	Precio
  	PROF30CSEX	30" Convection Steam Oven Profesional Series	Acero	\$3,143
	Especificaciones			
Worktop		Oven handle	metal	
Size	30 in	Shelf levels	2	
Oven configuration	single	Door hinges	soft-motion	
Oven fuel	electric	Removable water tank	33.8 fl.oz	
Oven type	combination electric			
Oven broiler type	convection and steam			
Oven functions	electric			
	broil / convection / convection broil / convection steam / steam only / descale / light / recipes / reheat / sterilize / timer / water hardness / setting			
Overall volume	1.34 ft ³	Technical specifications		
Oven convection system	1 fan	Electrical requirements	240 V - 60 Hz - 16 A	
Oven controls	touch LED display	Power rating	3200 W	
Inner oven door	double			
Removable inner glass	yes			
Cavity finishing	stainless steel			

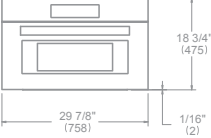
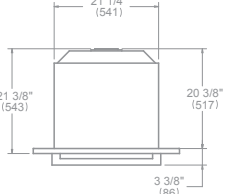
BERTAZZONI	Código	Descripción	Color	Precio
  	MAST30CSEX	30" Convection Steam Oven Master Series	Acero	\$3,143
	Especificaciones			
Worktop		Oven handle	metal	
Size	30 in	Shelf levels	2	
Oven configuration	single	Door hinges	soft-motion	
Oven fuel	electric	Removable water tank	33.8 fl.oz	
Oven type	combination electric			
Oven broiler type	convection and steam			
Oven functions	electric			
	broil / convection / convection broil / convection steam / steam only / descale / light / recipes / reheat / sterilize / timer / water hardness / setting			
Overall volume	1.34 ft ³	Technical specifications		
Oven convection system	1 fan	Electrical requirements	240 V - 60 Hz - 30 A	
Oven controls	touch LED display	Power rating	3200 W	
Inner oven door	double			
Removable inner glass	yes			
Cavity finishing	stainless steel			

MICROONDAS

BERTAZZONI	Código	Descripción	Color	Precio
	MO30STANE/16	Microwave Oven	Acero	\$1,197
	Especificaciones			
Worktop		Turnspit	1 Ø 16	
Size		30 in	Technical specifications	
Overall volume		2.00 ft ³	Electrical requirements	120 V - 60 Hz - 10 A
Cavity finishing		Enameled white	Power rating	1100 W
Microwave power levels		10 Levels		
Preset cooking mode functions		yes		
Multiple sequence cooking		4		
Sensor reheat, defrost, cook		yes		
Clock/Timer		yes		
Cook time function		yes		
Child lock		yes		

TRIMS

BERTAZZONI	Código	Descripción	Color	Precio
	FR30PROX	30" Built-in Trim for MO30STANE	Acero	\$313
	Especificaciones			
Size		30 in		
Type		Built-in Installation of MO30STANE 24" Microwave		
Finishing		stainless steel		

CAJONES CALIENTES

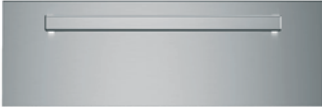
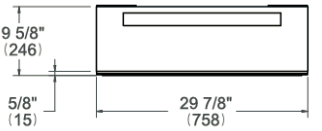
BERTAZZONI	Código	Descripción	Color	Precio
 	PROF30WDEX	30" Convection Warming Drawer	Acero	\$1,520
	Especificaciones			
Worktop				
Size		30 in		
Design		Stainless steel		
Volume		2.3 cu ft		
Cavity finishing		Tempered glass bottom		
Temperature range		85 - 170 °F		
Technical specifications				
Electrical supply		120 V - 60 Hz - 500 W 5 Amps		
Power connection		NEMA 5-15P with 59" power cord		
Certification		CETLUS		
Packaging dimensions and weight		W 26 3/8" H 13 1/2" D 32 3/4" 87.3 lbs		

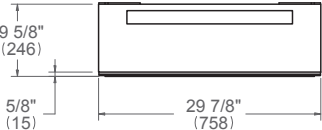
BERTAZZONI	Código	Descripción	Color	Precio
 	MAST30WDEX	30" Convection Warming Drawer	Acero	\$1,520
	Especificaciones			
Worktop				
Size		30 in		
Design		Stainless steel		
Oven Volume		2.3 cu ft		
Cavity finishing		Tempered glass bottom		
Temperature range		85 - 170 °F		
Technical specifications				
Electrical supply		120 V - 60 Hz - 500 W 5 Amps		
Power connection		NEMA 5-15P with 59" power cord		
Certification		CETLUS		
Packaging dimensions and weight		W 26 3/8" H 13 1/2" D 32 3/4" 87.3 lbs		



TERMINOS Y CONDICIONES

- Por ser nuestra línea de productos de importación, las listas de precios se manejan en dólares americanos y los artículos se liquidan en dolares americanos o pesos mexicanos al tipo de cambio que HOMEA este manejando el día de pago esto para evitar que paguen al tipo de cambio que maneje el banco o diario oficial. Los precios no incluyen IVA.
- El flete en todos los casos es por cobrar, con excepción de las ciudades de Monterrey, México, Guadalajara y sus zonas metropolitanas; siempre y cuando la orden de compra sea de un mínimo de **\$500.00 USD + IVA**.
- No nos hacemos responsables por los riesgos del transporte, por lo que es necesario inspeccionar perfectamente la mercancía recibida, y en caso de ser necesaria, efectuar la reclamación con anotación en la guía y fotografías del daño. Solo en caso de que la mercancía recibida sea mayor a 10 piezas se otorgará un plazo de 48 horas para su reclamación.

- Una vez que se haya recibido la confirmación de sus pedidos por escrito, no se aceptan cambios o cancelaciones.
- Para ordenes de producto especiales o manterial SKU será necesario un anticipo del 50%.

DEVOLUCIONES

- Toda la devolución debe tener una autorización previa por escrito por parte de HOMEA
- Únicamente se aceptan devoluciones de productos que manejamos para entrega inmediata.
- Es necesario que el producto a devolver se encuentre en perfecto estado así como su empaque, es decir, en condiciones de venderse como producto nuevo.
- Toda devolución causará un 20% de cargo.
- Toda devolución debe ser hecha con flete pagado por quien lo envía y asumir el riesgo de envío; si el producto presenta algún daño, no se aceptará y por consiguiente no se emitirá ninguna nota de crédito.
- Nos reservamos el derecho de aceptar o no una devolución.
- No se aceptan devoluciones después de 30 días de haber recibido el material.
- No se aceptan devoluciones de productos que no son SKU.

HOMEA
PREMIUM

HOMEA

www.homea.mx

Email: ventas@homea.mx

Whatsapp: (442)258.0251

Tel: (442)216.3552

Lada sin Costo: 01(800)701.2121