



LISTA DE PRECIOS 2026
COD-06022026



H·HOMEA
PREMIUM

HOMEA

www.homea.mx

Email: ventas@homea.mx

Whatsapp: (446)144.6318

Tel: (442)216.3552

Lada sin Costo: 01(800)701.2121

REFRIGERADORES

BERTAZZONI	Código	Descripción	Color	Precio
	RFD36FZNX	FREESTANDING COUNTER-DEPTH FRENCH DOOR REFRIGERATOR 36"	Stainless Steel	\$5,244
	HK36PROFD3X	Professional Handle Kit – Stainless Steel		\$476
	HK36MASFD3X	Master Handle Kit – Stainless Steel		\$535
	HK36MASFD3XG	Master Handle Kit – Stainless Steel w/ Gold Finials		\$615
	HK36HERFD3XG	Heritage Handle Kit – Stainless Steel w/Gold Finials <i>*Jaladeras adicionales no incluidas.</i>		\$793
Especificaciones				
Size	36 in	Ice maker	Automatic ice maker 2.6 lbs / 24 h	
Volume	Ref 18 cu.ft / Frz 8.2 cu.ft			
Door finish	No fingerprint stainless steel	Settings	Super cool, Super freeze, Water filter reset, Ice maker, Sabbath mode	
User interface	Internal digital LED touch interface			
Lighting	Top LED and side ambient LED lights	Technical specifications		
Refrigerator shelves	2 full-width and 2 height-adjustable half-width	Electrical supply	115 V 60 HZ	
		Power connection	NEMA 5-15P with 67" power cord	
Door storage	6 gallon-sized (4 fixed and 2 height-adjustable)	Sound rating	43 dbA	
		Water connection	1/4" waterline with shut-off valve	
Freezer compartment	1 deep drawer and 1 internal drawer	Water supply pressure	Min 0.15 MPa (1.5 bar, 21.32 PSI) Max 0.83 MPa (8.3 bar, 120.96 PSI)	
		Weight	282.00 lbs	



BERTAZZONI	Código	Descripción	Color	Precio
	REF36BMBZPNV	36 inch Bottom Mount Built-in Refrigerator Panel Ready with ice maker & internal water dispenser. Reversible door.	Panelable	\$8,907
	PROHK36PI	Handle kit - Professional series for REF36BMBZPNV (cod. tecnico 901462)		\$370
	MASHK36PI	Handle kit - Master series for REF36BMBZPNV (cod. tecnico 901463)		\$370
	HERHK36P	Handle kit - Heritage series for REF36BMBZPNV (cod. tecnico 901509)		\$740
	SP36BMX	Stainless steel door panels kit for REF36BMBZPNV (codigo tecnico 901609)		\$1,480
	CTXV	Union Kit for 2 units of REF36BMBZPNV (codigo tecnico 901602)		\$130
	Especificaciones			
Size	36 in	Door storage	1 gallon sized + 2 height adjustable bins	
Volume	Ref 14.2 cu.ft / Frz 5.6 cu.ft	Ice maker	Automatic ice maker 3.9 lbs / 24hrs	
Door finish	Panel Ready	Settings	Super cool, Super freeze, Ice maker, Water filter replacement alarm. Water dispenser, Eco mode, vacation mode. Sabbath mode.	
User interface	Internal digital LED touch interface			
Lighting	Top and sidewall LED lights			
Refrigerator shelves	1 stationary + 2 height-adjustable			
Refrigerator drawers	1 + 1 fresco drawer with separate temperature control	Technical specifications		
Freezer compartment	2 drawers	Electrical supply	115 V 60 HZ - 120 W - 3 Amp	
		Power connection	NEMA 5-15P with 90" power cord	
		Sound rating	43 dbA	
		Water connection	1/4" waterline with shut-o° valve	
		Water supply pressure	25-80 psi (1.7-5.5 bar)	
		Certification	ADA Compliant,CB,CEC,ETL	
		Warranty	2 years parts & labor	
		Packaging dimensions	W 38 3/16" H 90 9/16" D 26 3/8"	
		Weight	417.0 lbs	



BERTAZZONI	Código	Descripción	Color	Precio
	REF24BMBPNB	24" Bottom Mount integrated panel ready sliding door	Panelable Int.	\$2,027
	Especificaciones			
Worktop		Technical specifications		
Size	24 in	Voltage, Frequency, Amps	115 V 60 HZ - 85 W - 0.8 Amp	
Volume	Ref 6.2 cu.ft / Frz 2.4 cu.ft	Power Connection	NEMA 5-15P with 41" power cord	
Finishing	White	Certification	CEC / ETL	
Door finish	Panel ready	Energy star	Yes	
Interface	Internal digital LED touch interface	Warranty	2 years parts & labor	
Lighting	LED on top	Packaging dimensions and weight	W 22 7/16" H 72 7/16" D 22 9/16" Weight 139.0lbs	
Refrigerator shelves	1 stationary + 3 height adjustable			
Refrigerator drawers	1 + 1 fresco drawer with separate temperature and humidity control			
Freezer compartment	3 drawers			
Door storage	1 bin with lid - 2 height adjustable open bins			
Settings	Super cool, Super freeze, Eco mode, Vacation mode			

SIDE

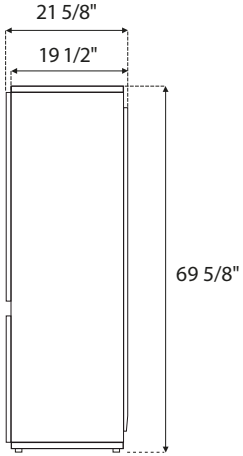

FRONT

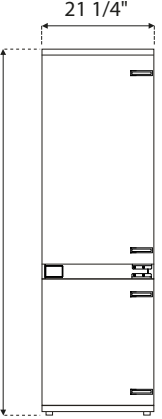

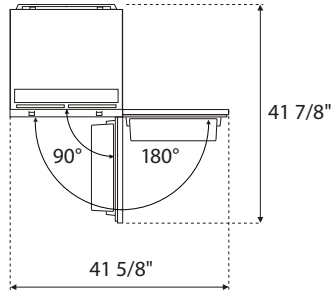

TOP



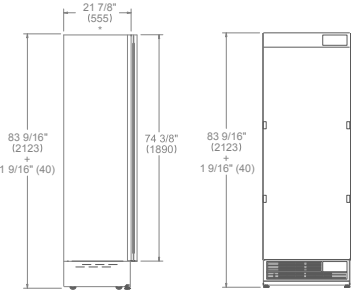

COLUMNAS DE REFRIGERADOR

BERTAZZONI	Código	Descripción	Color	Precio
 	REF30RCBPNV	30" Refrigerator (Larder), reversible, panel ready	Panelable	\$6,587
	Especificaciones			
Size	30 in	Refrigerator drawers	1 crisper + 3 Fresco drawers with separate temperature control	
Cooling system	frost free			
User interface	LED touch control interface	Door storage	1 height-adjustable gallon-sized bin + 2 stationary bins	
Display functions	Door ajar alarm, Super Cool, Water filter replacement reminder, Water dispenser, Eco Mode, Vacation Mode, Sabbath Mode	Water filter	internal	
		Water supply pressure	25 psi to 80 psi	
		Sound rating	43 dbA	
Lighting	LED side & top rail illumination	Certification	ADA Compliant, CEC, ETL	
Door ajar alarm	yes	DOE compliant	yes	
Door finishing	panel ready	Technical specifications		
Cabinet finishing	stainless steel back wall	Sound rating	43	
Refrigerator net capacity	16.7 cu.ft	Electrical supply	115 V - 60 Hz - 112 W - 2 Amp	
Refrigerator shelves	3 height-adjustable + 1 stationary	Power connection	NEMA 5-15P with 90" power cord	
		Energy consumption	325.0 kWh/yr	

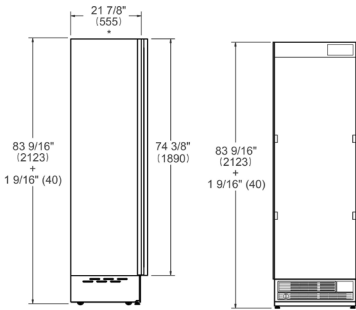
BERTAZZONI	Código	Descripción	Color	Precio
 	REF24RCBPNV	24" Refrigerator (Larder), reversible, panel ready	Panelable	\$6,180
	Especificaciones			
Size	24 in	Refrigerator drawers	1 crisper + 3 Fresco drawers with separate temperature control	
Cooling system	frost free			
User interface	LED touch control interface	Door storage	1 height-adjustable gallon-sized bin + 2 stationary bins	
Display functions	Door ajar alarm, Super Cool, Water filter replacement reminder, Water dispenser, Eco Mode, Vacation Mode, Sabbath Mode	Water filter	internal	
		Water supply pressure	25 psi to 80 psi	
		Sound rating	41 dbA	
Lighting	LED side & top rail illumination	Certification	ADA Compliant, CEC, ETL	
Door ajar alarm	yes	DOE compliant	yes	
Door finishing	panel ready	Technical specifications		
Cabinet finishing	stainless steel back wall	Sound rating	41	
Refrigerator net capacity	12.5 cu.ft	Electrical supply	115 V - 60 Hz - 112 W - 2 Amp	
Refrigerator shelves	3 height-adjustable + 1 stationary	Power connection	NEMA 5-15P with 90" power cord	
		Energy consumption	295.0 kWh/yr	

COLUMNAS DE CONGELADOR

BERTAZZONI	Código	Descripción	Color	Precio
	REF18FCBIPLV	18" Freezer, left hinge, panel ready	Panelable	\$5,440
	Especificaciones			
Size	18 in	Freezer drawers	4	
Cooling system	frost free	Automatic ice maker	yes	
User interface	LED touch control interface	Ice production capacity	3.9 lbs/24hrs	
Display functions	Door ajar alarm, Super Freeze, Ice maker, Water filter replacement reminder, Eco mode, Vacation mode, Sabbath mode	Water filter	internal	
		Water supply pressure	25 psi to 80 psi	
		Sound rating	43 dbA	
		Certification	ADA Compliant, CEC, ETL	
Lighting	LED lights on sides and top	DOE compliant	yes	
Door ajar alarm	yes			
Door finishing	panel ready			
Cabinet finishing	stainless steel back wall			
Door storage	3 height-adjustable bins			
Freezer net capacity	8.6 cu.ft ³			
Freezer shelves	3 height-adjustable + 1 stationary			
Technical specifications				
		Sound rating	43	
		Electrical supply	115 V - 60 Hz - 160 W - 2 Amp	
		Power connection	NEMA 5-15P with 90" power cord	
		Energy consumption	452.0 kWh/yr	

BERTAZZONI	Código	Descripción	Color	Precio
	REF24FCBIPNV	24" Freezer, reversible, panel ready	Panelable	\$5,995
	Especificaciones			
Size	24 in	Freezer drawers	4	
Cooling system	frost free	Automatic ice maker	yes	
User interface	LED touch control interface	Ice production capacity	3.9 lbs/24hrs	
Display functions	Door ajar alarm, Super Freeze, Ice maker, Water filter replacement alarm, Eco mode, Vacation mode, Sabbath mode	Water filter	yes	
		Water supply pressure	25 psi to 80 psi	
		Sound rating	41 dbA	
		Certification	ADA Compliant, CEC, ETL	
Lighting	LED lights on sides and top	DOE compliant	yes	
Door ajar alarm	yes			
Door finishing	panel ready			
Cabinet finishing	stainless steel back wall			
Freezer net capacity	12.4 cu.ft ³			
Freezer shelves	3 height-adjustable + 1 stationary			
Technical specifications				
		Sound rating	41	
		Electrical supply	115 V - 60 Hz - 160 W - 2 Amp	
		Power connection	NEMA 5-15P with 90" power cord	
		Energy consumption	511.0 kWh/yr	

COLUMNAS DE CAVA DE VINOS

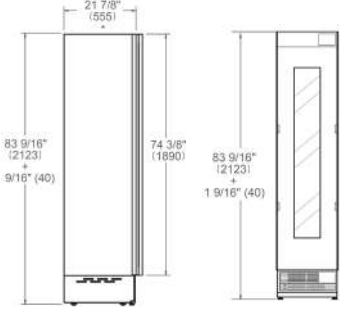
BERTAZZONI	Código	Descripción	Color	Precio
 	REF18WCBPRV	18" Wine Cellar, right hinges, panel ready	Panelable	\$5,995
	Especificaciones			
Size	18 in	Technical specifications		
Cooling system	Three temperature zones	Electrical supply	115 V - 60 Hz - 1.5 A	
User interface	LED touch control interface	Power rating	150W	
Display functions	Entertainment mode, Light color selection, Sabbath mode, Showroom mode	Power connection	NEMA 5-15P with 90" power cord	
		Energy consumption	226.0 kWh/yr	
Lighting	LED lights interior illumination			
Door ajar alarm	yes			
Door finishing	panel ready			
Cabinet finishing	stainless steel back wall			
Wine racks	14 wooden shelves			
Bottle capacity	68 bottles			
Sound rating	41 dbA			
Certification	DOE Compliant, ETL			

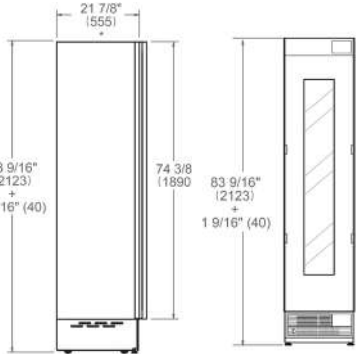
BERTAZZONI	Código	Descripción	Color	Precio
 	REF18WCBPLV	18" Wine Cellar, left hinges, panel ready	Panelable	\$5,995
	Especificaciones			
Size	18 in	Technical specifications		
Cooling system	Three temperature zones	Electrical supply	115 V - 60 Hz - 1.5 A	
User interface	LED touch control interface	Power rating	150W	
Display functions	Entertainment mode, Light color selection, Sabbath mode, Showroom mode	Power connection	NEMA 5-15P with 90" power cord	
		Energy consumption	226.0 kWh/yr	
Lighting	LED lights interior illumination			
Door ajar alarm	yes			
Door finishing	panel ready			
Cabinet finishing	stainless steel back wall			
Wine racks	14 wooden shelves			
Bottle capacity	68 bottles			
Sound rating	41 dbA			
Certification	DOE Compliant, ETL			

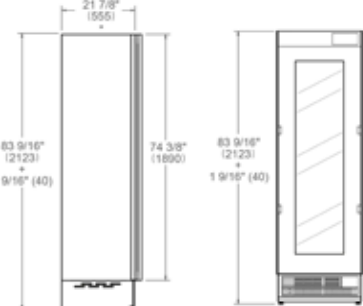
BERTAZZONI	Código	Descripción	Color	Precio
 	REF24WCBPNV	24" wine cellar, reversible, panel ready	Panelable	\$6,365
	Especificaciones			
Size	24 in	Technical specifications		
Cooling system	Three temperature zones	Electrical supply	115 V - 60 Hz - 1.5 A	
User interface	LED touch control interface	Power rating	150W	
Display functions	Entertainment mode, Light color selection, Sabbath mode, Showroom mode	Power connection	NEMA 5-15P with 90" power cord	
		Energy consumption	252.0 kWh/yr	
Lighting	LED lights interior illumination			
Door ajar alarm	yes			
Door finishing	panel ready			
Cabinet finishing	stainless steel back wall			
Wine racks	14 wooden shelves			
Bottle capacity	100 bottles			
Sound rating	41 dbA			
Certification	DOE Compliant, ETL			

ACCESORIOS

ACCESORIOS PARA REFRIGERADORES		
Código	Descripción	Precio
SP18CX	Steel panels for REF18FCBIP.V	\$1,110
SP30CX	Steel panels for REF30RCBPNV	\$1,480
SP24CX	Steel panels for columns RED24 (RC&FC)	\$1,258
MASHKCOL	Master Series handle kit for premium columns	\$320
PROHKCOL	Professional Series handle kit for premium columns	\$334
HERHKCOL	Heritage Series handle kit for premium columns	\$280
901667	Carbonio Panels for Column REF18FC	\$1,554
901665	Carbonio Panels for Column REF24RC/FC	\$1,697
901666	Carbonio Panels for Column REF30RC/FC	\$1,911
901664	Carbonio Panels for Column REF36RC	\$2,050
901669	Professional Titanium Handle for Columns	\$170
9100277	Custom Panel handle insert kit	\$113
PROHK36PI	Handle kit - Professional series for REF36BMBZPNV (cod. tecnico 901462)	\$370
MASHK36PI	Handle kit - Master series for REF36BMBZPNV (cod. tecnico 901463)	\$370
HERHK36P	Handle kit - Heritage series for REF36BMBZPNV (cod. tecnico 901509)	\$740
BHFDX	Heritage Handle Kit – Stainless Steel w/Gold Finials	\$119
ACCESORIOS PARA CAVAS		
Código	Descripción	Precio
SP18WXV	Steel panels for REF18WCBPV	\$1,110
SP24WXV	Steel panels for REF24WCBPNV	\$1,258
901663	Carbonio Panels for Wine Column REF18W	\$1,554
901662	Carbonio Panels for Wine Column REF24W	\$1,713

*Si las columnas se van a panelar y requieren usar las jaladeras de la marca, se requiere cotizar el Kit #9100277 para la instalación de las jaladeras en los paneles de cocina. Este Kit no se requiere cuando se instala con el panel de acero.

ESTUFAS 36" MASTER SERIES

BERTAZZONI	Código	Descripción	Color	Precio
	MAS365GASXVLP	36" Master Series range - Gas oven - 5 aluminum burners (Conversion kit included)	Acero	\$5,271
	MAS365GASNG	36" Master Series range - Gas oven - 5 aluminum burners (Conversion kit included)	Negro	\$5,945
	MAS365GASBG	36" Master Series range - Gas oven - 5 aluminum burners (Conversion kit included)	Blanco	\$5,945
Especificaciones				
Worktop		Oven Cavity		
Size	36 in	Oven configuration	single	
Cooking zones	5	Oven fuel	gas	
Gas zones	5	Oven type	fan assisted gas	
Worktop type	gas	Oven broiler type	gas	
Worktop design	stainless steel squared	Cooking modes	bake / broiler / convection bake	
Worktop controls	Knobs	Oven volume	5.9 ft ³	
Knobs	solid metal	Oven convection system	dual horizontal fans	
Burner type	aluminium	Oven controls	knobs / thermometer	
Grates	cast iron	Inner oven door	triple	
Continuous grating	yes	Removable inner glass	yes	
Thermocouple safety device	yes	Cooling fan	yes	
One-hand ignition	yes	Oven levels	7	
Backguard	yes	Door hinge	soft-motion	
Wok ring	yes	Wire-shelves	2 standard with handle	
Simmer ring	yes	Tray	1 baking tray with grill trivet	
Cooking zones		Grill trivet for tray	yes	
Power burners	1300 BTU/h - 19 000 BTU/h (1)	Oven lights	double lateral	
Rapid burner	2500 BTU/h - 10 400 BTU/h (1)	Bottom		
Medium burner	1500 BTU/h - 5900 BTU/h (2)	Legs	stainless steel	
Simmer burner	750 BTU/h - 3500 BTU/h (1)	Technical specifications		
		Absorbed current (A)	2.5 A with dedicated circuit	
		Electrical supply	110V 60 Hz - 300W	

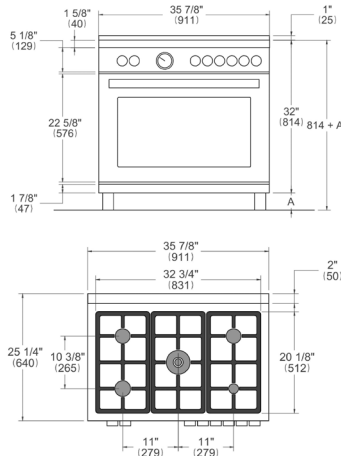

ESTUFAS 36" PROFESSIONAL SERIES

BERTAZZONI	Código	Descripción	Color	Precio
	PRO366BCFGMXT	36" Professional Series range - Gas oven - 6 brass burners	Acero	\$6,795
	PRO366BCFGMNET	36" Professional Series range - Gas oven - 6 brass burners *Hasta agotar existencias	Negro	\$8,857
	PRO366BCFGMBIT	36" Professional Series range - Gas oven - 6 brass burners *Hasta agotar existencias	Blanco	\$8,857
	PRO366BCFGMGIT	36" Professional Series range - Gas oven - 6 brass burners	Amarillo	\$8,857
	PRO366BCFGMART	36" Professional Series range - Gas oven - 6 brass burners	Naranja	\$8,857
	PRO366BCFGMROT	36" Professional Series range - Gas oven - 6 brass burners	Rojo	\$8,857
	PRO366BCFGMXTLP	36" Professional Series range - Gas oven - 6 brass burners LP Version	Version LP	\$6,795
	PRO366BCFGMCAT	36" Professional Series range - Gas oven - 6 brass burners	Carbonio	\$8,857

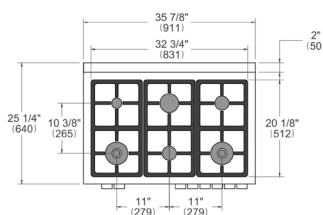
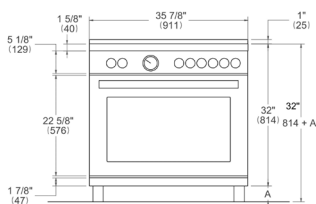

Especificaciones

Worktop		Oven Cavity	
Size	36 in	Oven configuration	single
Cooking zones	6	Oven fuel	gas
Gas zones	6 Burners	Oven type	fan assisted gas
Worktop type	gas	Oven broiler type	gas
Worktop design	stainless steel squared	Oven functions	bake / broiler / convection bake
Knobs	metal coated	Oven volume	5.9 ft ³
Burner type	brass	Oven convection system	dual horizontal fans
Grates	cast iron	Inner oven door	triple
Continous grating	yes	Removable inner glass	yes
Thermocouple safety device	yes	Cooling fan	yes
One-hand ignition	yes	Oven levels	7
Backguard	yes	Door hinge	soft-close
Wok ring	yes	Sliding shelves	2 sets of telescopic glides
Simmer ring	yes	Wire-shelves	2 heavy duty
Cast iron griddle	yes	Tray	1 baking tray with grill trivet
		Grill trivet for tray	yes
		Oven lights	double lateral
Cookinf zones		Bottom	
Power burners	1300 BTU/h - 19 000 BTU/h (2)	Legs	stainless steel
Rapid burner	2500 BTU/h - 10 400 BTU/h (1)		
Medium burner	1500 BTU/h - 5900 BTU/h (2)	Technical specifications	
Simmer burner	900 BTU/h - 3500 BTU/h (1)	Absorbed current (A)	2.5 A with dedicated circuit
		Electrical supply	110V 60 Hz - 300W



ESTUFAS 48" MASTER SERIES

BERTAZZONI	Código	Descripción	Color	Precio
	MAS486GGASXVLP	48" Master Series range - Gas Oven - 6 aluminum (Conversion kit included)	Acero Version LP	\$9,989
	MAS486GGASNG	48" Master Series range - Gas Oven - 6 aluminum burners+ griddle	Negro	\$10,795
	MAS486GGASBG	48" Master Series range - Gas Oven - 6 aluminum burners+ griddle	Blanco	\$10,795
Especificaciones				
Worktop		Oven Cavity		
Size	48 in	Oven configuration	double	
Cooking zones	7	Oven fuel	gas	
Gas zones	6 Burners	Oven convection system	dual horizontal fans	
Griddle zones	electric	Main oven type	fan assisted gas	
Worktop type	electric / gas	Main oven broiler type	gas	
Worktop design	stainless steel squared	Main oven functions	bake / broiler / convection bake	
Worktop controls	Knobs	Main oven volume	4.7 ft ³	
Knobs	solid metal	Auxiliary oven type	gas conventional	
Burner type	aluminium	Auxiliary oven functions	bake	
Grates	cast iron	Auxiliary oven volume	2.4 ft ³	
Continous grating	yes	Oven control	knobs / thermometer	
Thermocouple safety device	yes	Inner oven door	triple	
One-hand ignition	yes	Removable inner glass	yes	
Backguard	yes	Cooling fan	yes	
Simmer ring	yes	Oven levels	7	
Cookinf zones		Door hinge	soft-motion	
Power burners	1300 BTU/h - 19 000 BTU/h (2)	Wire-shelves	2 each cavity	
Rapid burner	2500 BTU/h - 10 400 BTU/h (1)	Tray	1 baking tray with grill trivet	
Medium burner	1500 BTU/h - 5900 BTU/h (2)	Grill trivet for tray	yes	
Simmer burner	750 BTU/h - 3500 BTU/h (1)	Oven lights	double lateral	
Griddle power	1100 W	Bottom		
		Legs	stainless steel	
		Technical specifications		
		Absorbed current (A)	10 A with dedicated circuit	
		Electrical supply	110V 60 Hz - 1200W	

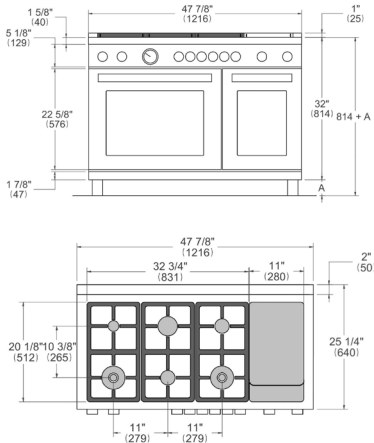

ESTUFAS 48" PROFESSIONAL SERIES

BERTAZZONI	Código	Descripción	Color	Precio
	PRO486BTFGMXT	48" Professional Series range - Gas Oven - 6 brass burners + griddle	Acero	\$11,378
	PRO486BTFGMNET	48" Professional Series range - Gas Oven - 6 brass burners + griddle <i>*Hasta agotar existencias</i>	Negro	\$12,979
	PRO486BTFGMBIT	48" Professional Series range - Gas Oven - 6 brass burners + griddle <i>*Hasta agotar existencias</i>	Blanco	\$12,979
	PRO486BTFGMGIT	48" Professional Series range - Gas Oven - 6 brass burners + griddle	Amarillo	\$12,979
	PRO486BTFGMART	48" Professional Series range - Gas Oven - 6 brass burners + griddle	Naranja	\$12,979
	PRO486BTFGMROT	48" Professional Series range - Gas Oven - 6 brass burners + griddle	Rojo	\$12,979
	PRO486BTFGMXTLP	48" Professional Series range - Gas Oven - 6 brass burners + griddle	Versión LP	\$11,378
Especificaciones				
Worktop		Oven Cavity		
Size	48 in	Oven configuration	double	
Cooking zones	7	Oven fuel	gas	
Gas zones	6 Burners	Oven type	gas conventional	
Griddle zones	electric	Oven convection system	dual horizontal fans	
Worktop type	electric / gas	Main oven type	fan assisted gas	
Worktop design	stainless steel squared	Main oven broiler type	gas	
Worktop controls	knobs	Main oven functions	bake / broiler / convection bake / defrosting	
Knobs	metal coated	Main oven volume	4.7 ft ³	
Burner type	brass	Auxiliary oven type	gas conventional	
Grates	cast iron	Auxiliary oven broiler type	gas	
Continous grating	yes	Auxiliary oven functions	bake	
Thermocouple safety device	yes	Auxiliary oven volume	2.4 ft ³	
One-hand ignition	yes	Oven controls	knobs / thermometer	
Backguard	yes	Inner oven door	triple	
Wok ring	yes	Removable inner glass	yes	
Simmer ring	yes	Cooling fan	yes	
Cookinf zones		Oven levels	7	
Power burners	1300 BTU/h - 19 000 BTU/h (2)	Food probe	yes	
Rapid burner	2500 BTU/h - 10 400 BTU/h (1)	Door hinge	soft-close	
Medium burner	1500 BTU/h - 5900 BTU/h (2)	Sliding shelves	2 sets of telescopic glides	
Simmer burner	750 BTU/h - 3500 BTU/h (1)	Wire-shelves	2 each cavity	
Griddle power	1100 W	Tray	1 baking tray with grill trivet	
Griddle dual control	yes	Grill trivet for tray	yes	
Griddle drip tray	yes	Oven lights	double lateral	
Bottom				
Legs		stainless steel		
Technical specifications				
Absorbed current (A)		10 A with dedicated circuit		
Electrical supply		110 V 60 Hz - 1200W		

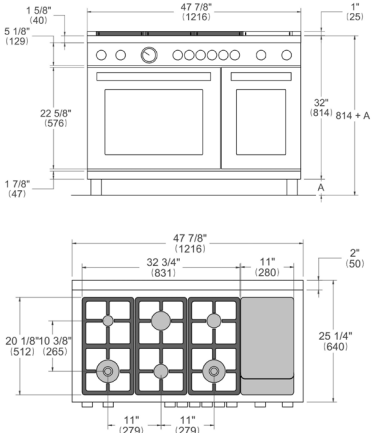

ESTUFAS SERIE HERITAGE 36"

BERTAZZONI	Código	Descripción	Color	Precio
	HER366BCFGMNG	36" Heritage Series range - Gas Oven - 6 brass burners	Negro	\$8,861
	HER366BCFGMXG	36" Heritage Series range - Gas Oven - 6 brass burners	Acero	\$8,861
	HER366BCFGMAG	36" Heritage Series range - Gas Oven - 6 brass burners	Crema	\$8,861
Especificaciones				
Worktop		Oven Cavity		
Size	36 in	Oven configuration	single	
Cooking zones	6	Oven fuel	gas	
Gas zones	6 Burners	Oven type	fan assisted gas	
Worktop type	gas	Oven broiler type	gas	
Worktop design	stainless steel squared	Cooking modes	bake/broil/convection bake	
Worktop controls	knobs	Oven volume	5.9 ft ³	
Knobs	solid metal	Oven convection system	dual horizontal fans	
Burner type	brass	Oven controls	knobs/thermometer	
Grates	cast iron	Inner oven door	triple	
Continuous grating	yes	Removable inner glass	yes	
Thermocouple safety device	yes	Cooling fan	yes	
One-hand ignition	yes	Oven levels	7	
Backguard	yes	Food probe	yes	
Work adapter	yes	Door hinges	soft-close	
Wok ring	yes	Sliding shelves	2 set of telescopic glides	
Simmer ring	yes	Wire-shelves	2 heavy duty	
Cast iron griddle	yes	Tray	1 baking tray with grill trivet	
Cooking zones		Grill trivet for tray	yes	
Power Burners	1300 BTU/h - 19 000 BTU/h (2)	Oven lights	double lateral	
Rapid Burner	2500 BTU/h - 10 400 BTU/h (1)	Bottom		
Medium Burner	1500 BTU/h - 5900 BTU/h (2)	Legs	stainless steel	
Simmer Burner	750 BTU/h - 3500 BTU/h (1)			
Technical specifications				
Absorbed current (A)	2.5 A with dedicated circuit			
Electrical supply	110V 60 Hz - 300W			

CAMPANAS SERIE HERITAGE 36"

BERTAZZONI	Código	Descripción	Color	Precio
	KC36HERTX	36" Canopy Hood Stainless	Acero	\$1,117
	KC36HERTAV	36" Canopy Hood Ivory	Crema mate	\$1,117
	KC36HERTNE	36" Canopy Hood Nero	Negro	\$1,117
Especificaciones				
Worktop		Lights	2 LED	
Size	36 in	Hood finishing	stainless steel and matt or glossy color	
Hood		Sound rating	1.3 - 8.6 Sones	
Hood type	wallmount	Max extraction power	600 CFM	
Hood control	electronic with buttons	Technical specifications		
Duct cover	included	Electrical supply	120 V - 60 Hz - 3.30 A	
Motor	1	Power rating	400 W	
Speed	3			
Filters type	ba°e stainless steel			
Motor para campana HERITAGE 36"				
K36HERTX	Motor 600 CFMS			\$2,066
*Se debe cotizar Campana más Motor.				









CAMPANAS SERIE HERITAGE 48"

BERTAZZONI	Código	Descripción	Color	Precio
	KC48HERTX	48" Canopy Hood Stainless	Acero	\$1,388
	KC48HERTAV	48" Canopy Hood Ivory	Crema mate	\$1,388
	KC48HERTNE	48" Canopy Hood Nero	Negro mate	\$1,388
Especificaciones				
Worktop		Lights	2 LED	
Size	48 in	Hood finishing	stainless steel and matt or glossy color	
Hood		Sound rating	1.3 - 8.6 Sones	
Hood type	wallmount	Max extraction power	600 CFM	
Hood control	electronic with buttons	Technical specifications		
Duct cover	included	Electrical supply	120 V - 60 Hz - 3.30 A	
Motor	1	Power rating	400 W	
Speed	3			
Filters type	ba°e stainless steel			
Motor para campana HERITAGE 48"				
K48HERTX	Motor 600 CFMS			\$2,246
*Se debe de cotizar campana + motor.				

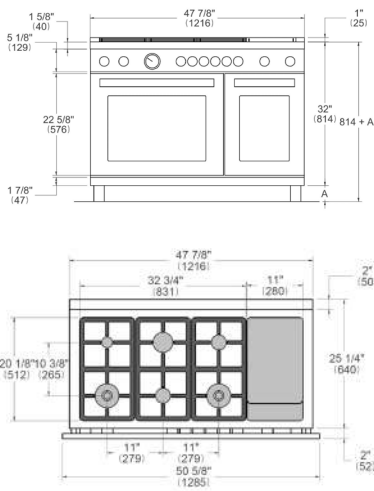

ESTUFAS SERIE HERITAGE 48"

BERTAZZONI	Código	Descripción	Color	Precio
	HER486BTFGMNG	48" Heritage Series range - Gas Oven - 6 brass burners + griddle <i>*Igual que la imagen, pero con pomos y jaladeras doradas.</i>	Negro	\$14,052
	HER486BTFGMXG	48" Heritage Series range - Gas Oven - 6 brass burners + griddle <i>*Igual que la imagen, pero con pomos y jaladeras doradas.</i>	Acero	\$14,052
	HER486BTFGMAG	48" Heritage Series range - Gas Oven - 6 brass burners + griddle <i>*Igual que la imagen, pero con pomos y jaladeras doradas.</i>	Crema	\$14,052
Especificaciones				
Worktop		Oven Cavity		
Size	48 in	Oven configuration	double	
Cooking zones	7	Oven fuel	gas	
Gas zones	6 Burners	Oven type	gas conventional	
Griddle zones	electric	Oven convection system	dual horizontal fans	
Worktop type	electric / gas	Main oven type	fan assisted gas	
Worktop design	stainless steel squared	Main oven broiler type	gas	
Worktop controls	knobs	Main oven functions	bake/broiler/convection bake/defrosting	
Knobs	solid metal	Main oven volume	4.7 ft ³	
Burner type	brass	Auxiliary oven type	gas conventional	
Grates	cast iron	Auxiliary oven broiler type	gas	
Continous grating	yes	Auxiliary oven functions	bake	
Thermocouple safety device	yes	Auxiliary oven volume	2.4 ft ³	
One-hand ignition	yes	Oven controls	knobs/thermometer	
Backguard	yes	Inner oven door	triple	
Wok ring	yes	Removable inner glass	yes	
Simmer ring	yes	Cooling fan	yes	
Cookinf zones		Oven levels	7	
Power burners	1300 BTU/h - 19 000 BTU/h (2)	Food probe	yes	
Rapid burner	2500 BTU/h - 10 400 BTU/h (1)	Door hinges	soft-close	
Medium burner	1500 BTU/h - 5900 BTU/h (2)	Sliding shelves	2 sets of telescopic glides	
Simmer burner	750 BTU/h - 3500 BTU/h (1)	Wire-shelves	2 each cavity	
Griddle power	1100 W	Tray	1 baking tray with grill trivet	
Griddle dual control	yes	Grill trivet for tray	yes	
Griddle drip tray	yes	Oven lights	double lateral	
Technical specifications		Bottom		
Absorbed current (A)	10 A with dedicated circuit	Legs	stainless steel	
Electrical supply	110V 60 Hz - 1200W			



ACCESORIOS OPCIONALES ESTUFAS

Código	Descripción	Precio
901309	Satainless Steel Grid SG36X (Works for rangetops and DB an QB Cooktops)	\$630
901472	Satainless Steel Grid CIG36 (Works for all ranges)	\$238

DECOR SET PARA CAMPANA Y ESTUFA HERITAGE 36" - 48"

Código	Descripción	Precio
DSHERTKHGO	Decor Set 1- Range & Hood Kit : Gold Finish	\$1,978
DSHERTKHPC	Decor Set 1- Range & Hood Kit : Polished Copper Finish	\$1,978
DSHERTKHSB	Decor Set 1- Range & Hood Kit : Matt Satin Black Finish	\$1,978

DECOR SET PARA ESTUFAS MASTER 36" - 48"

Código	Descripción	Precio
DSMASGKSG	10 x knobs in Gold	\$1,190
DSMASGKSB	10 x knobs in Black Nickel	\$1,190
DSMASHSG	2 x handle finials in Gold	\$397
DSMASHSB	2 x handle finials in nickel	\$397



PARRILLAS DE INDUCCIÓN PROFESSIONAL SERIES

BERTAZZONI	Código	Descripción	Precio
<p>30" Induction Cooktop 4 Induction Zones - TFT Display</p>	PE304TB	30" Induction Cooktop 4 Induction Zones - TFT Display	\$3,263
	Especificaciones		
Worktop		Cooking zones	
Size	30 in	Induction 2 bridge zones	yes
Cooking zones	4	Induction front left	2100W (3700 W booster)
Induction zones	54	Induction back left	2100W (3700 W booster)
Worktop type	induction	Induction center	(N.A. W booster)
Worktop design	ceramic glass bevelled	Induction front right	1400W (2200 W booster)
Worktop controls	touch controls	Induction back right	N.A.W
		Technical specifications	
		Electrical supply	208 V, 60 Hz 240 V 60 HZ W
		Power rating	7400 W

BERTAZZONI	Código	Descripción	Precio
<p>36" - Induction Hob - TFT Display - Bertazzoni Assistant</p>	P365ITB	36" - Induction Hob - TFT Display - Bertazzoni Assistant	\$4,472
	Especificaciones		
Worktop		Cooking zones	
Size	36 in	Induction front left	(2100W (3700 W booster)
Cooking zones	5	Induction back left	2100W (3700 W booster)
Induction zones	5	Induction front right	1400W (2200 W booster)
Worktop type	induction	Induction back right	2300W (3700 W booster)
Worktop design	ceramic glass bevelled		
Worktop controls	touch controls		
		Technical specifications	
		Electrical supply	208 V , 60 Hz - 240 V 60 HZ W
		Power rating	11100 W W



PARRILLAS ENCIMERAS DE GAS BERTAZZONI

BERTAZZONI	Código	Descripción	Color	Precio
	P905Cprox	90cm Gas on steel Cooktop, 5 Brass Burners	Acero	\$1,219
	Especificaciones			
	Worktop		Cooking zones	
	Size	90 cm	Front right	1 auxiliary 0.48 kW - 1.00 kW
	Worktop surface	stainless steel	Back right	1 rapid 1.05 kW - 3.00 kW
	Layout	5 burners	Center	1 wok dual 0.48 kW - 5.00 kW
	Worktop controls	knobs	Front left	1 semi-rapid 0.60 kW - 1.75 kW
	Knobs	metal	Back left	1 semi-rapid 0.60 kW - 1.75 kW
	Pan supports	cast iron	Technical specifications	
	Burner type	brass	Electrical requirements	220/240, 50/60 Hz, 1A, 1W
Work burner	5 kW dual			
Flame failure device	-			
One-hand ignition	-			
Standard accessories	-			

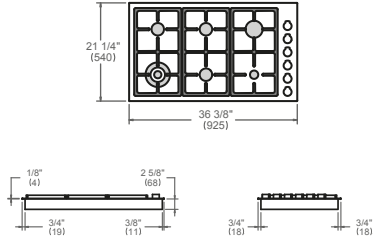
BERTAZZONI	Código	Descripción	Color	Precio
 	MAST366QBXT	36" Built-in cooktop master series	Acero	\$1,918
	Especificaciones			
	Worktop		Cooking zones	
	Size	36 in	Griddle zones	electric
	Maintop	6 burner	Worktop type	electric/gas
	Burner power	1 power burners 17000 BTU 1 rapid burner 10400 BTU 3 medium burners 6000 BTU 1 simmer burner 3750 BTU	Worktop desing	stainless steel
	Ignition system	Electric with thermocouple safety device	Knobs	solid metal
			Burner type	brass
	Technical specifications			
	Grates	Cast iron	Electrical requirements	120 V - 60 Hz - 1 A
		Power rating	1 W	

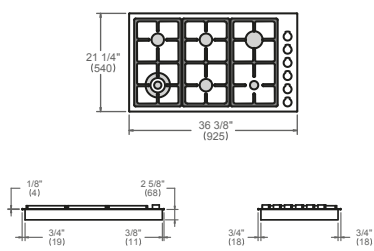
BERTAZZONI	Código	Descripción	Color	Precio
 	PROF366QBXT	36" Built-in cooktop profesional series	Acero	\$1,918
	Especificaciones			
	Worktop		Cooking zones	
	Size	36 in	Griddle zones	electric
	Maintop	6 burner	Worktop type	electric/gas
	Burner power	1 power burners 17000 BTU 1 rapid burner 10400 BTU 3 medium burners 6000 BTU 1 simmer burner 3750 BTU	Worktop desing	stainless steel
	Ignition system	Electric with thermocouple safety device	Knobs	solid metal
			Burner type	brass
	Technical specifications			
	Grates	Cast iron	Electrical requirements	120 V - 60 Hz - 1 A
		Power rating	0.01 W	

PARRILLAS DE GAS

BERTAZZONI	Código	Descripción	Color	Precio
	PROF486GRTBXT	48" Rangetop 6 Brass Burners + Griddle Professional Series	Acero	\$4,128
	Especificaciones			
Worktop		Cooking zones	7	
Size	48 in	Griddle zones	electric	
Maintop	6 burners + stainless steel griddle with cover	Worktop type	electric/gas	
Burner power	2 power burners 19000 BTU	Worktop desing	stainless steel squared	
	1 rapid burner 10400 BTU	Knobs	solid metal	
	2 medium burners 5900 BTU	Burner type	brass	
1 simmer burner 3500 BTU		Technical specifications		
Ignition system	Electric with thermocouple safety device	Electrical requirements	120 V - 60 Hz - 10 A	
Grates	Cast iron	Power rating	1100 W	

BERTAZZONI	Código	Descripción	Color	Precio
	MAST486GRTBXT	48" Rangetop 6 Brass Burners + Griddle Master Series	Acero	\$4,128
	Especificaciones			
Worktop		Cooking zones	7	
Size	48 in	Griddle zones	electric	
Maintop	6 burners + stainless steel griddle with cover	Worktop type	electric/gas	
Burner power	2 power burners 19000 BTU	Worktop desing	stainless steel squared	
	1 rapid burner 10400 BTU	Knobs	solid metal	
	2 medium burners 5900 BTU	Burner type	brass	
1 simmer burner 3500 BTU		Technical specifications		
Ignition system	Electric with thermocouple safety device	Electrical requirements	120 V - 60 Hz - 10 A	
Grates	Cast iron	Power rating	1100 W	



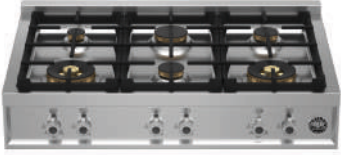
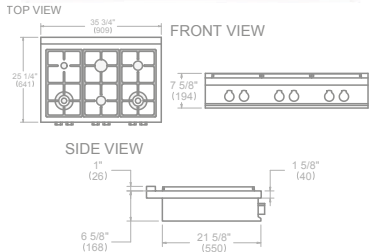

BERTAZZONI	Código	Descripción	Color	Precio
 	PROF366RTBXT	36" Rangetop 6 Brass Burners Professional Series	Acero	\$2,695
	Especificaciones			
Worktop		Cooking zones	6	
Size	36 in	Griddle zones	electric	
Maintop	6 burner	Worktop type	electric/gas	
Burner power	2 power burners 19000 BTU 1 rapid burner 10400 BTU 2 medium burners 5900 BTU 1 simmer burner 3500 BTU	Worktop desing	stainless steel	
		Knobs	solid metal	
		Burner type	brass	
Ignition system	Electric with thermocouple safety device	Technical specifications		
Grates	Cast iron	Electrical requirements	120 V - 60 Hz - 1 A	
		Power rating	1 W	

BERTAZZONI	Código	Descripción	Color	Precio
 	MAST366RTBXT	36" Rangetop 6 Brass Burners Master Series	Acero	\$2,695
	Especificaciones			
Worktop		Cooking zones	6	
Size	36 in	Griddle zones	electric	
Maintop	6 burner	Worktop type	electric/gas	
Burner power	2 power burners 19000 BTU 1 rapid burner 10400 BTU 2 medium burners 5900 BTU 1 simmer burner 3500 BTU	Worktop desing	stainless steel	
		Knobs	solid metal	
		Burner type	brass	
Ignition system	Electric with thermocouple safety device	Technical specifications		
Grates	Cast iron	Electrical requirements	120 V - 60 Hz - 1 A	
		Power rating	0.01 W	



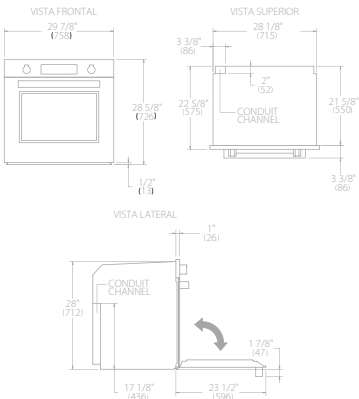

HORNOS CONVECCIÓN 30"

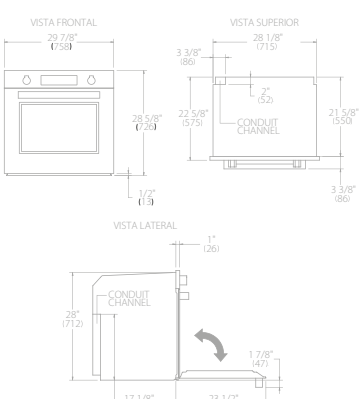
BERTAZZONI	Código	Descripción	Color	Precio
 	PROF30FSEXT	30" Single Convection Oven Top Version Profesional Series	Acero	\$5,586
	Especificaciones			
Worktop		Cavity finishing	pyrolytic grey enamel	
Size	30 in	Oven handle	metal	
Oven configuration	single	Cooling fan	yes	
Oven fuel	electric	Oven levels	7	
Oven type	self-clean	Timer	touch digital programmer	
Oven broiler type	electric	Auto cooking modes	33 preset / with assistant	
Oven functions	bake / broiler / convection / convection bake / convection broiler / defrosting / dehydrate / proofing / pyrolytic self clean / turbo / warming	Door hinge	soft-motion	
Overall volume	4.10 ft ³	Sliding shelves	1 full extension	
		Wire-shelves	2 heavy gauge chromed	
Oven convection system	dual diagonal with heating element	Tray	1 enamelled	
		Grill trivet for tray	yes	
Oven controls	knobs / touch LCD hi res display	Oven lights	double	
Inner oven door	quadruple	Technical specifications		
Removable inner glass	yes	Electrical requirements	120/240 Vac - 60 Hz - 30 A	
		Power rating	5400 W	

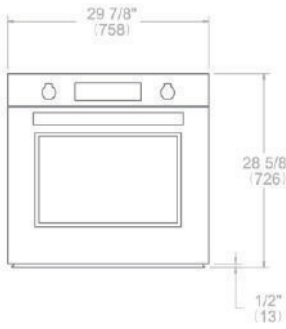
BERTAZZONI	Código	Descripción	Color	Precio
 	MAST30FSEXT	30" Single Convection Oven Top Version Master Series	Acero	\$5,586
	Especificaciones			
Worktop		Oven handle	metal	
Size	30 in	Cooling fan	yes	
Oven configuration	single	Oven levels	7	
Oven fuel	electric	Timer	touch digital programmer	
Oven type	self-clean	Door hinge	soft-close	
Oven broiler type	electric	Wire-shelves	2 heavy gauge chromed	
Oven functions	bake / broiler / convection / convection bake / convection broiler / defrosting / dehydrate / proofing / pyrolytic self clean / turbo / warming	Tray	1 enamelled	
Overall volume	4.10 ft ³	Grill trivet for tray	yes	
		Oven lights	single	
Oven convection system	dual diagonal with heating element	Technical specifications		
Oven controls	knobs / touch LED display	Electrical requirements	120/240 V - 60 Hz - 30 A	
Inner oven door	quadruple	Power rating	5400 W	
Removable inner glass	yes			
Cavity finishing	pyrolytic grey enamel			

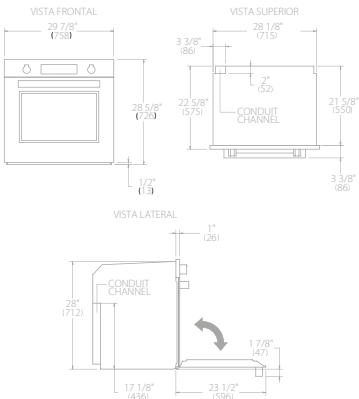
BERTAZZONI	Código	Descripción	Color	Precio
 	PROF30FSEXV	30" Single Convection Oven Value Version Profesional Series	Acero	\$4,157
	Especificaciones			
Worktop		Oven handle	metal	
Size	30 in	Cooling fan	yes	
Oven configuration	single	Oven levels	7	
Oven fuel	electric	Timer	touch digital programmer	
Oven type	self-clean	Door hinge	soft-motion	
Oven broiler type	electric	Wire-shelves	1 flat / 1 shaped	
Oven functions	bake / broil / convection / convection bake / convection broil / defrosting / dehydrate / proofing / pyrolytic self clean / pizza / sabbath mode / warming	Tray	1 baking tray whit roasting trivet	
Overall volume	4.10 ft ³	Grill trivet for tray	yes	
Oven convection system	dual diagonal with heating element	Oven lights	single	
Oven controls	knobs / touch LED display	Technical specifications		
Inner oven door	quadruple	Electrical requirements	120/240 V - 60 Hz - 30 A	
Removable inner glass	yes	Power rating	5400 W	
Cavity finishing	pyrolytic grey enamel			

BERTAZZONI	Código	Descripción	Color	Precio
 	MAST30FSEXV	30" Single Convection Oven Value Version Master Series	Acero	\$4,157
	Especificaciones			
Worktop		Oven handle	metal	
Size	30 in	Cooling fan	yes	
Oven configuration	single	Oven levels	7	
Oven fuel	electric	Timer	touch digital programmer	
Oven type	self-clean	Door hinge	soft-motion	
Oven broiler type	electric	Wire-shelves	2 heavy gauge chromed	
Oven functions	bake / broil / convection / convection bake / convection broil / pizza / defrost / dehydrate / fast preheat / keep warm / light / proof / self clean / timer	Tray	1 enamelled	
Overall volume	4.10 ft ³	Grill trivet for tray	yes	
Oven convection system	dual diagonal with heating element	Oven lights	single	
Oven controls	knobs / touch LED display	Technical specifications		
Inner oven door	quadruple	Electrical requirements	120/240 V - 60 Hz - 30 A	
Removable inner glass	yes	Power rating	5400 W	
Cavity finishing	pyrolytic grey enamel			

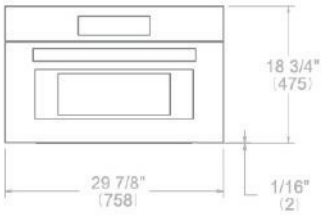
BERTAZZONI	Código	Descripción	Color	Precio
 	PROF30SOEX	30" Convection Speed Oven Profesional Series	Acero	\$3,177
	Especificaciones			
Worktop		Oven handle	metal	
Size	30 in	Microwave power	200 / 400 / 600 / 800 / 1000	
Oven configuration	single	Oven levels	2	
Oven fuel	electric	Timer	yes	
Oven type	self-clean	Door hinge	soft-motion	
Oven broiler type	electric	Wire-shelves	1 flat / 1 shaped	
Oven functions	broil / convection / microwave / convection broil / microwave whit broiler/ pizza / defrost by time / defrost by weight / light / popcorn / recipes / timer	Tray	1 glass	
Overall volume	1.34 ft ³	Grill trivet for tray	yes	
Oven convection system	single whit ring heating element	Oven lights	single	
Oven controls	touch LED display	Technical specifications		
Inner oven door	double	Electrical requirements	120/240 V - 60 Hz - 16 A	
Removable inner glass	yes	Power rating	1500 W	
Cavity finishing	stainless steel			

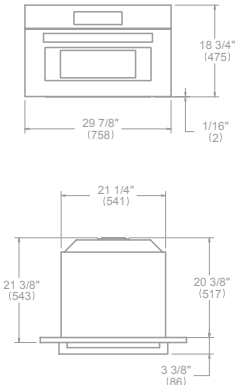
BERTAZZONI	Código	Descripción	Color	Precio
 	MAST30SOEX	30" Convection Speed Oven Master Series	Acero	\$3,177
	Especificaciones			
Worktop		Oven handle	metal	
Size	30 in	Microwave power	200 / 400 / 600 / 800 / 1000	
Oven configuration	single	Oven levels	2	
Oven fuel	electric	Timer	yes	
Oven type	self-clean	Door hinge	soft-motion	
Oven broiler type	electric	Wire-shelves	1 flat / 1 shaped	
Oven functions	broil / convection / microwave / convection broil / microwave whit broiler/ pizza / defrost by time / defrost by weight / light / popcorn / recipes / timer	Tray	1 glass	
Overall volume	1.34 ft ³	Grill trivet for tray	yes	
Oven convection system	single whit ring heating element	Oven lights	single	
Oven controls	touch LED display	Technical specifications		
Inner oven door	double	Electrical requirements	120/240 V - 60 Hz - 30 A	
Removable inner glass	yes	Power rating	1500 W	
Cavity finishing	stainless steel			

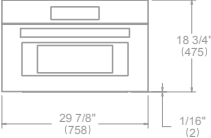
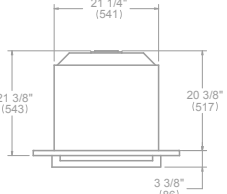
BERTAZZONI	Código	Descripción	Color	Precio
  	PROF30CSEX	30" Convection Steam Oven Profesional Series	Acero	\$3,311
	Especificaciones			
Worktop		Oven handle	metal	
Size	30 in	Shelf levels	2	
Oven configuration	single	Door hinges	soft-motion	
Oven fuel	electric	Removable water tank	33.8 fl.oz	
Oven type	combination electric			
Oven broiler type	convection and steam			
Oven functions	electric			
	broil / convection / convection broil / convection steam / steam only / descale / light / recipes / reheat / sterilize / timer / water hardness / setting			
Overall volume	1.34 ft ³	Technical specifications		
Oven convection system	1 fan	Electrical requirements	240 V - 60 Hz - 16 A	
Oven controls	touch LED display	Power rating	3200 W	
Inner oven door	double			
Removable inner glass	yes			
Cavity finishing	stainless steel			

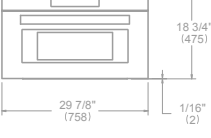
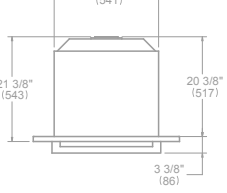
BERTAZZONI	Código	Descripción	Color	Precio
  	MAST30CSEX	30" Convection Steam Oven Master Series	Acero	\$3,311
	Especificaciones			
Worktop		Oven handle	metal	
Size	30 in	Shelf levels	2	
Oven configuration	single	Door hinges	soft-motion	
Oven fuel	electric	Removable water tank	33.8 fl.oz	
Oven type	combination electric			
Oven broiler type	convection and steam			
Oven functions	electric			
	broil / convection / convection broil / convection steam / steam only / descale / light / recipes / reheat / sterilize / timer / water hardness / setting			
Overall volume	1.34 ft ³	Technical specifications		
Oven convection system	1 fan	Electrical requirements	240 V - 60 Hz - 30 A	
Oven controls	touch LED display	Power rating	3200 W	
Inner oven door	double			
Removable inner glass	yes			
Cavity finishing	stainless steel			

HORNO CONVECCIÓN 24"

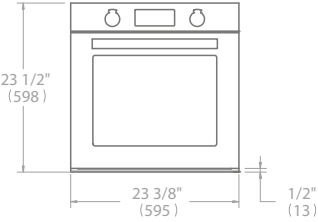
BERTAZZONI	Código	Descripción	Color	Precio
 	PROF24FSEXV	24" Electric Convection Oven Professional Series	Acero	\$1,633
	Especificaciones			
Worktop		Cavity finishing	black enamel	
Size	24 in	Oven handle	metal	
Oven configuration	Single	Cooling fan	yes	
Oven fuel	Electric	Oven levels	5	
Oven broiler type	Electric	Timer	touch digital programmer	
Cooking modes	bake / bottom bake / broil / convection / convection bake / convection broil / defrosting dehydrate / fast preheat / oven light / pizza / proofing turbo / upper bake	Door hinges	soft-motion	
		Wire-shelves	1 flat / 1 shaped	
		Tray	1 baking tray with roasting trivet	
Technical specifications				
Gross volume oven	2.70 ft ³	Electrical supply	120/240 V 60 Hz - 2800 W 208/240 V 60 Hz - 2100 W 16 Amp dedicated circuit	
Oven convection system	single	Power rating	Bake: 2050 W / Broiler: 2400 W / Convection: 1800 W	
Oven controls	knobs / touch LED display	Power connection	metal conduit 59" power cord	
Inner oven door	triple	Certification	UL	
Removable inner glass	yes			

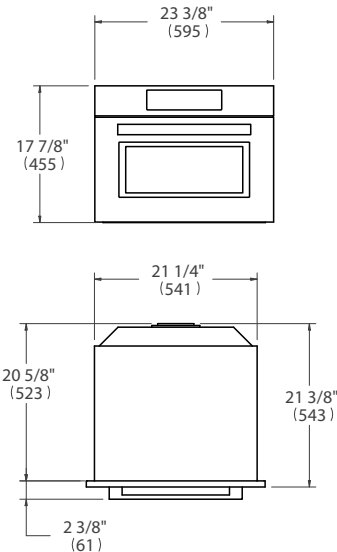
BERTAZZONI	Código	Descripción	Color	Precio
 	PROF24SOEX	24" - Convection Speed Oven Professional Series	Acero	\$2,717
	Especificaciones			
Worktop		Grill trivet for tray	yes	
Special functions	defrost by time / defrost by weight / light / popcorn / recipes timer	Turntable quantity	1 glass	
Size	24 in			
Microwave type	combi-microwave			
Functions	broil / convection / microwave / convection broil microwave / microwave with broiler / pizza			
Technical specifications				
Total volume	1.34 ft ³	Electrical supply	240 V - 60 HZ - 3850 W / 16 Amp dedicated circuit Broiler: 1500 W / Convection: 1600 W	
Oven convection system	single	Power connection	NEMA 6-20P with 71" power cord	
Oven controls	touch LED display	Certification	CETLUS	
Auto cooking modes	yes			
Inner oven door	double			
Removable inner glass	yes			
Cavity finishing	stainless steel			
Oven levels	2			
Microwave power levels	200 / 400 / 600 / 800 / 1000			
Clock/Timer	yes			
Tray	1 glass			

MICROONDAS

BERTAZZONI	Código	Descripción	Color	Precio
	MO30STANE/16	30" Microwave Oven	Acero	\$1,358
	Especificaciones			
Worktop		Sensor reheat, defrost, cook	yes	
Size	30 in	Clock/Timer	yes	
Overall volume	2.00 ft ³	Cook time function	yes	
Cavity finishing	Enameled white	Child lock	yes	
Microwave power levels	10 Levels	Turnspit	1 Ø 16	
Preset cooking mode functions	yes	Technical especifications		
Multiple sequence cooking	4	Electrical requirements	120 V - 60 Hz - 10 A	
		Power rating	1100 W	



TRIMS

BERTAZZONI	Código	Descripción	Color	Precio
	FR30PROX	30" Built-in Trim for MO30STANE	Acero	\$322
	Especificaciones			
Size	30 in			
Type	Built-in Installation of MO30STANE 24" Microwave			
Finishing	stainless steel			



BERTAZZONI	Código	Descripción	Color	Precio
	FPRO30COVTX	30" Combo oven with Steam Assist	Acero	\$10,398
	FPRO30COSTX	30" Combo oven with Steam Assist	Acero	\$8,566
	FPRO30COVTC	30" Combo oven with Steam Assist	Carbonio	\$10,398
Especificaciones				
Worktop		Technical specifications		
Size	30 in	Electrical requirements	120/208 V – 60 Hz	
Oven configuration	single	Power rating	– 8800 W	
Oven fuel	electric	Electrical requirements	120/240 V – 60 Hz	
Oven type	Pyrolytic steam oven	Power rating	– 11000 W	
Oven broiler type	electric			
Oven functions	Assistant / Defrost / Dehydrate / Energy saving mode / Fast preheat / Keep warm / Light / Proof / Sabbath mode / Self clean / Timer			
Oven Volume	4.8 cu.ft.			
Microwave Volume	1.6 cu.ft.			
Oven convection system	1 fan			
				

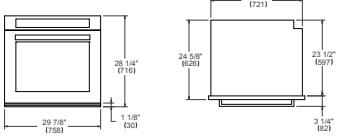

BERTAZZONI	Código	Descripción	Color	Precio
  	FPRO30FSSTX	30" Single oven with Self Clean	Acero	\$4,501
	FPRO30FSVTC	30" Single oven with Self Clean	Carbonio	\$6,333
	FPRO30FSVTX	30" Single oven with Self Clean	Acero	\$5,967
Especificaciones				
Worktop		Technical specifications		
Size	30 in	Electrical requirements	120/208 V 60HZ –	
Oven configuration	single	Power rating	4400 W	
Oven fuel	electric	Electrical requirements	120/240 V 60 HZ –	
Oven type	Electric convection self-clean with electric broiler	Power rating	5500 W	
Oven broiler type	Electric			
Oven functions	Defrost / Dehydrate / Fast preheat / Keep warm / Light / Proof / Sabbath mode / Self clean / Timer			
Oven convection system	1 fan			

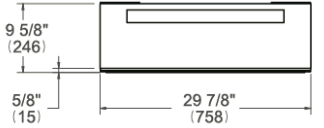

CAJONES CALIENTES

BERTAZZONI	Código	Descripción	Color	Precio
 	PROF30WDEX	30" Convection Warming Drawer	Acero	\$1,566
	Especificaciones			
Worktop		Technical specifications		
Size	30 in	Electrical supply	120 V - 60 Hz - 500 W 5 Amps	
Design	Stainless steel	Power connection	NEMA 5-15P with 59" power cord	
Volume	2.3 cu ft	Certification	CETLUS	
Cavity finishing	Tempered glass bottom	Packaging dimensions and weight	W 26 3/8" H 13 1/2" D 32 3/4" 87.3 lbs	
Temperature range	85 - 170 °F			

BERTAZZONI	Código	Descripción	Color	Precio
 	MAST30WDEX	30" Convection Warming Drawer	Acero	\$1,566
	Especificaciones			
Worktop		Technical specifications		
Size	30 in	Electrical supply	120 V - 60 Hz - 500 W 5 Amps	
Design	Stainless steel	Power connection	NEMA 5-15P with 59" power cord	
Oven Volume	2.3 cu ft	Certification	CETLUS	
Cavity finishing	Tempered glass bottom	Packaging dimensions and weight	W 26 3/8" H 13 1/2" D 32 3/4" 87.3 lbs	
Temperature range	85 - 170 °F			

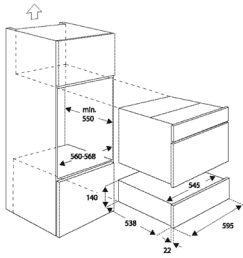
BERTAZZONI	Código	Descripción	Color	Precio
 	WD60PROX	24" Warming Drawer Professional Series	Acero	\$1,112
	Especificaciones			
Worktop		Technical specifications		
Size	24 in	Voltage and frequency	220/240 V - 50/60 Hz	
Design	Stainless steel	Absorbed power (W)	400 W	
Controls	push/pull with soft motion operation	Equipment	inner rubber matt / thermostat light on/o°	
Carring capacity	25kg	Max temperature	85°C	

CAMPANA

BERTAZZONI	Código	Descripción	Color	Precio
	KIN36XV	36" - Insert Hood, 1 motors 560 CFM Professional Series	Acero	\$1,293
	Especificaciones			
	Hood		Technical specifications	
	Size	36 in	Electrical supply	110 V - 60 Hz - 3.30 A
	Hood type	built-in	Power rating	410 W
	Hood control	electronic with buttons	Power connection	NEMA 5-15P with 59" power cord
	Motor	1	Certification	CEC, UL
	Speed	3 + booster		
	Filters type	aluminum mesh		
	Lights	2 LED		
Hood finishing	stainless steel			
Duct size	6" diameter			
Sound rating	1.5 - 6 Sones			
Max extraction power	560 CFM			
Accesorios				
	901531	Charcoal Filters for Kin Hoods		\$91
	901532	Durable Charcoal Filters for Kin Hoods		\$365
	901575	Remote Control for Kin Hoods		\$139

LAVAVAJILLAS

BERTAZZONI	Código	Descripción	Color	Precio
	DW24T3IPV	24" - Dishwasher Tall Tub Panel Ready, Professional Series	Acero	\$2,029
	Especificaciones			
	Worktop		Technical specifications	
	Size	24 in	Delayed start	yes
	Place setting	15	Lighting	floor projection status light
	Controls	concealed multi-button	Drying system	PowerDry Plus
	Interior finish	stainless steel	Overflow protection device	yes
	User interface	LED display	Filter system	triple stage metal filter
	Spray arms	3	Certification	CEC, NSF, UL
	Number of racks	3		
Cutlery basket	sliding	Electrical supply	120 V - 60 Hz - 12 A	
Wash cycle	6 - auto, crystal and china, pots and pans, quick, regular, rinse and hold	Power rating	1400 W	
Wash Options	7 - accel, extra dry, delay start, 3 half load modes, sanitize, scrub, stealth	Energy consumption	234 kWh	
Accesorios				
	HK24PRODWX	Handle Kit for 24 Dishwasher Professional series		\$159
	HK24MASDWX	Handle Kit for 24 Dishwasher Master Series		\$159
	HK24HERDWX	Handle Kit for 24 Dishwasher Heritage Series		\$159
	901661	Carbonio Panels for dishwasher DW24T		\$884
	901668	Profesional Titanium Handle for Dishwasher		\$226

CAFETERA

BERTAZZONI	Código	Descripción	Color	Precio
	CM242WXT	24" Built-In Coffee Machine with Stainless Steel Panels	Acero	\$5,543
	Especificaciones			
Worktop		Technical specifications		
Size	24 in	Electrical supply	120 V - 60 Hz - 1350 W 6 Amp	
Design	Stainless steel	Power connection	67" power cord with plug	
User interface	Full touch TFT display 4.3"	Automatic rising	yes	
Certification	UL	Automatic descaling	yes	
		Coffee length	extra large/large/medium/ small	
		Pump pressure	15 bar	



HOMEA

P R E M I U M

H O M E A

www.homea.mx

Email: ventas@homea.mx

Whatsapp: (446)144.6318

Tel: (442)216.3552

Lada sin Costo: 01(800)701.2121